

CONFÉDÉRATION
ORNITHOLOGIQUE
MONDIALE



ORDRE
MONDIAL
DES - JUGES

STANDARDS O.M.J./C.O.M. TYPE CANARIES

Property of C.O.M. / O.M.J. – Reproduction strictly prohibited /
Santa Maria da Feira - Portugal 2024 Congress OMJ section E1/ E2



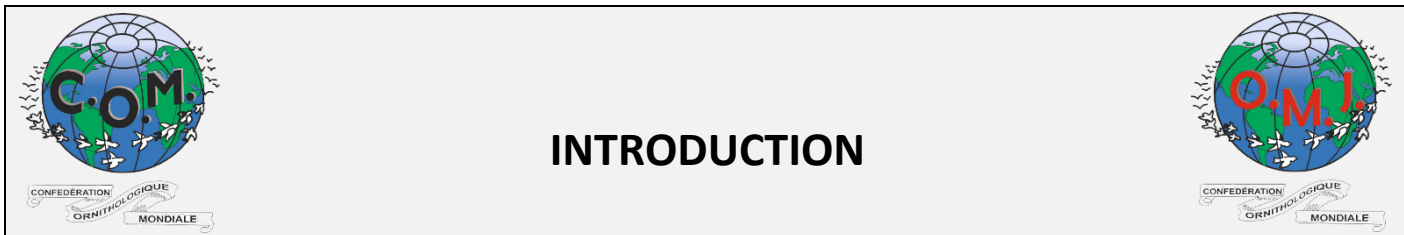

At the initiative of the Interim President of the O.M.J., Candido Lorenzo Vidal, under the direction of the responsible for OMJ Section E Jorge Quintas, a meeting of expert judges of type canaries was held. The following countries were physically present: Germany, Spain, Portugal, the Netherlands, France, United Kingdom, Belgium, Turkey and Lebanon. By ZOOM: Uruguay and Serbia. These 11 countries met in Santa Maria da Feira, Portugal, on the 10th August 2024 to establish the update of these standards:

STANDARDS O.M.J. / C.O.M. OF TYPE CANARIES

The work they have done has allowed us to establish this document, which must be an important reference for all O.M.J. judges and for all breeders.

We hope that it will allow good harmonization among all member countries.

Updated January 2025

President of O.M.J.

João Liberado

Responsible Section E

Jorge Quintas

The elaboration of a standard is a work that involves the collaboration of a large team worldwide, for which OMJ is grateful for its collaboration.

The reproduction and use of all or part of these documents is prohibited without the authorization of their authors and the COM/OMJ (photos and text).

Only this version is recognized by the COM. All earlier versions are obsolete.



Table of Contents

• STANDARDS O.M.J. / C.O.M. OF TYPE CANARIES	3
• Smooth Feathers.....	7
• Section E1	7
• Frills.....	8
• Section E2	8
• Generalities and Judgement.....	9
• Variety.....	9
• Colors	10
• Shape and Size	13
• Plumage.....	14
• Maintenance and Position	15
• Condition, Well-being and Impression	16
• Stamm Definition.....	16
• Harmony.....	18
• Criteria for Non Judgement.....	19
• Criteria for Wrong Class	19
• Criteria for Disqualification	20
• BREED AND COUNTRY OF ORIGIN	21
• ENGLAND.....	21
• ITALY	22
• SPAIN.....	22
• GERMANY.....	23
• FRANCE.....	23
• SWITZERLAND.....	23
• BELGIUM	23
• JAPAN / BELGIUM	24
• PORTUGAL.....	24
• IRAN	24
• STANDARDS O.M.J. / C.O.M. OF TYPE CANARIES	25
• E1	25
• Portuguese Harlequin	26
• German Crest (Deutsche Haube)	30
• Irish Fancy.....	35
• Lizard	39
• London Fancy.....	44
• Gloster.....	49
• Crested/Crestbred	53
• Norwich	57
• Rasmi.....	61
• Border	65
• Fife Fancy.....	70
• Japanese Hoso	74
• Raza Española	78
• Scotch Fancy	82
• Bernois	86
• Belgian Bossu.....	90
• Llarguet Español	94



- Lancashire (Coppo/Plainhead).....98
- Münchener 102
- Rheinländer 106
- Salentino 110
- Yorkshire 114
- **STANDARDS O.M.J. / C.O.M. OF TYPE CANARIES** 118
- **E2**..... 118
- Frills - Section E2 119
- Benacus 121
- Gibber Italicus..... 125
- Giboso Español 129
- Giraldillo Sevillano 133
- South Frill 137
- Swiss Frill 141
- Mélado Tinerfeño 145
- Fiorino 149
- AGI (Arricciato Gigante Italiano) 153
- North Frill 157
- Parisian Frill 161
- Mehringer..... 165
- Padovan..... 169
- Rogetto..... 173



Smooth Feathers

Section E1

- 1) Portuguese Harlequin
 - Crested (Poupa)
 - Non-Crested (Par)
- 2) Bernois
- 3) Border
- 4) Belgian Bossu
- 5) Crest
 - Crested
 - Crestbred
- 6) Fife Fancy
- 7) Gloster
 - Corona
 - Consort
- 8) Japanese Hoso
- 9) German Crest
- 10) Irish Fancy
- 11) Lancashire
 - Crested (Copy)
 - Non-Crested (Plainhead)
- 12) Lizard
 - Blue (white ground)
 - Golden (intensif, intensif red)
 - Silver (non-intensive, non-intensive red)
- 13) London Fancy
- 14) Llarguet Español
- 15) Münchener
- 16) Norwich
- 17) Raza Española



- 18) Rasmi Persian
- 19) Rheinländer
 - Crested
 - Non-Crested
- 20) Scotch Fancy
- 21) Salentino
 - Crested
 - Non-Crested
- 22) Yorkshire

Frills Section E2

- 1) A.G.I.
- 2) Fiorino
 - Crested
 - Non-Crested
- 3) Parisian Frill
- 4) Swiss Frill
- 5) South Frill
- 6) North Frill
- 7) Gibber Italicus
- 8) Giboso Español
- 9) Giraldillo Sevillano
- 10) Mehringer
- 11) Mélado Tinerfeño
- 12) Padovano
 - Crested
 - Non-Crested
- 13) Rogetto
- 14) Benacus



Generalities and Judgement

Section E – Type canaries, bred by the owner

Variety

- White background
- 100% Lipochrome
- Variegated Lipochrome
- 100 % Melanin
- Variegated Melanin

Except for :

Cinnamon Class : When existing, all cinnamon must go inside it, including variegated or melanine, intensive or non intensive unless existing intensive class, crest or non crest without white ground. ***Also includes all other different melanine : agate, isabel, pastel, jaspe, satinette, phaeo etc., without white ground.***

Lancashire (only lipochrome)

White (melanin accepted only in the crest)

Yellow (melanin accepted only in the crest)

Lizard (only melanin)

Blue (white ground)

Gold (yellow intensive and red intensive ground)

Silver (yellow non-intensive and red non-intensive ground)

Rheinländer (only lipochrome)

White (melanin accepted only in the crest)

Yellow (melanin accepted only in the crest)

Red (melanin accepted only in the crest)

Portuguese Harlequin (red mosaïque factor, mandatory variegated)

German Crest

Same as color canaries (melanin accepted only in the crest for the lipochromes).



Colors

<i>Red Factor allowed</i>	<i>Red factor not allowed</i>
AGI	Bernois
Portuguese Harlequin	Border
Benacus	Belgian Bossu
Fiorino	Crest
North Frill	Fife Fancy
Parisian Frill	Swiss Frill
South Frill	Gloster
Gibber Italicus	Irish fancy
Giboso Español	Lancashire
Giraldillo Sevillano	London Fancy
German Crest	Münchener
Japanese Hoso	Rasmi
Lizard	Scotch Fancy
Llarguet Español	
Mehringer	
Mélado Tinerfeño	
Norwich	
Padovan	
Rheinländer	
Rogetto	
Salentino	
Yorkshire	
Raza Española	

Characteristics

Typical color of the variety according to the standard.



Pigment analysis (from the poephila monograph)

Considering that color is not a physical property of the objects around us, but rather a decoding of our brain that receives and processes certain information from the environment (electromagnetic waves that affect the field of view).

In fact, each of us distinguishes the different chromatic tones thanks to our entire visual system perceiving the range of reflected waves in space that determine the spectrum of vision.

Therefore, before analyzing this part of the judgment sheet, it is essential, both for a correct evaluation of the subjects, to understand the genetic mechanism of their mutations, and to know that the coloration is given by the pigments and the special structure of the plumage.

The pigments are distinguished in:

➤ **Lipochromes**, which attributes coloration by means of carotenoids acquired from the diet:

- Astaxanthine red color
- Lutein yellow color

➤ **Melanins**, which in turns are distinguished by :

- Eumelanin, which attributes to the plumage, depending on the concentration, the colors that go from black to dark brown;
- Pheomelanin, which attributes to the plumage, depending on the concentration, the colors that range from rust to yellow.

Lipochrome

Lipochromes are fatty pigments, which are generated in the bird, according to their diet, are deposited in the feathers, giving them their relative specific color. They are soluble in oils and fats. This dye is also observed in vegetables and called carotenoid, it gives rise to the yellow and red colors of the feathers. Different tones of lipochrome, depending on the concentration of it on the pen, generate precise gradations on the interested parts.



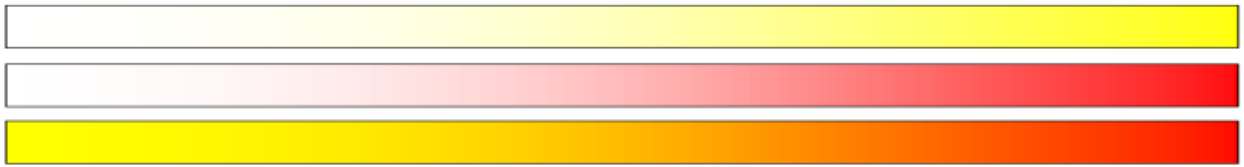

Melanin

Melanins are the other major group of pigments that give color to animals. It is a dark pigment, which is found in some cells of the body of animals. The main biological function is to protect individuals from ultraviolet rays, absorbing harmful radiation and transforming energy into harmless heat through a process called ultrafast internal conversion. This property allows melanin to dissipate more than 99.9% of the radiation absorbed by heat. These pigments are produced by the body, unlike lipochromes which are incorporated according to their diet.

Black eumelanin

Black eumelanin is a pigment present in all species of their ancestral variety. As the name suggests, it gives the bird black tones, provided that the feathers have a normal structure that allows them to absorb all the light waves they receive. As in lipochromes, black eumelanin can have infinite shades depending on the degree of presence in the feather. The more concentrated the pigment, the more black, intense and shiny tones will be obtained.



All feathers have the keratin layer, which covers the central area of the feather, where melanic pigments are located.

Brown Eumelanin

Brown eumelanin is given by a mutation. This mutation causes an alteration of the enzymes involved in the process of melanogenesis, reason why they are verified changes in it and the ancestral black eumelanin, becomes brown.

By itself, this pigment has the same characteristics as black eumelanin. The only variation is the tone it will bring to the bird's plumage. Similarly, under the normal structure of the feather will produce brown and/or brown shades.



As with black eumelanin in brown we can find infinite amounts of shades, which vary from the lightest to the darkest depending on the degree of concentration of the pigment that the feather possesses, ranging from very dark brown in cases of high concentration and tone, to light beige or cream in areas of great dispersion.

Pheomelanin

Pheomelanin, like black eumelanin, is found in almost all birds in their ancestral (classical) form.

It is the most interesting pigment to analyze given the wide range of shades it offers us depending on the degree of concentration, but mainly because unlike the pigments already considered (shades and tones in the same color range) pheomelanin has different colors (ochre yellow, rusty red, light brown, etc.) and each of them with a minor or major degree of expression, depending on the concentration of the pigment on large feathers and / or small feathers (example of small feathers, chest and back).

As well as the effect of light waves first absorbed by the feather and then refracted.

Shape and Size

Characteristics

Typical shape and size of the variety according to the standard.

Penalizing defects that do not correspond to the standard of the breed:

- Size : smaller or larger
- Head : flat or too small, or on the contrary too large and heavy in proportion with the body
- Back : concave or convex not corresponding to the standard of the breed
- Chest : flat or narrow or prominent and massive
- Trunk : too thin or too massive
- Legs : too long with a thin tibia and visible thighs, or too short or covered with plumage from the abdomen.

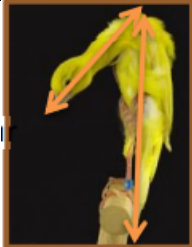
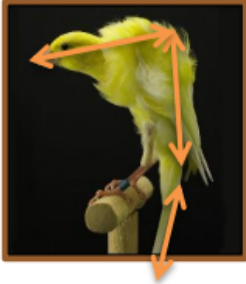
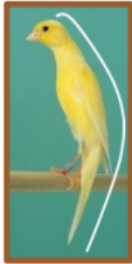
Way of measuring the size of a canary	
For breeds of normal position, are measured by the existing distance between the top of the head and the tip of the tail.	
For breeds with angular position, it is the sum of the lengths from the tip of the beak to the highest part of the shoulders plus the length of this part of the shoulders to the tip of the tail.	
For elliptical breeds, it is the sum of the lengths formed from the tip of the beak to the shoulders, from there to the base of the tail and from there to the tip of the tail.	
For “bowed” breeds it is the length of the arc from the top of the head to the tip of the tail.	

Plumage

Characteristics

The plumage consists of feathers and quills. It should be complete, intact, uniform, smooth, compact, tight and shiny (Except for frills canaries).

The feathers will have to overlap each other like well-ordered tiles.

The tail and wings should be compact, closed and intact.

Penalizing defects that do not correspond to the standard of the breed:

- Plumage too long and abundant, making the mantle less compact.
- Plumage too abundant on the flanks, eyebrows too bushy and marked.
- Split in the throat and on the chest
- Loose plumage on one or both flanks, abdomen or chest
- Rooster feathers (except in some frill canaries and the Crest)
- Back with feathers that tend to separate
- Short and sparse plumage (except in Gibber, Giboso and Giraldillo)
- Not finished moult
- Remiges and rectrices not uniform (with regrowing feathers)
- Broken remiges and rectrices (wings and tail)
- Wing feathers not complete and not uniformly in-line
- Fan or/and swallow tail are considered "serious defects"

Maintenance and Position

Attitude and position of the bird, in movement, not amorphous.

Characteristics

By position, we mean the attitude of the body of the subject and how it presents itself on the perch in the cage.

So the form and position, often compare and influence each other. A canary in which the form leaves something to be desired will hardly have a good position and vice versa. Excellent form can be summarized as: strength, pride and vivacity.

There are two types of penalty faults:

1. Character

- Wild or restless
- Shy and fearful



2. Structural

- Wings carried too low and slack along the body
- Crossed wings
- Tail carried too low with a concave or convex tail body line, not corresponding to the standard

Condition, Well-being and Impression

A bird will have a good impression if it presents itself clean and healthy.

Condition of the bird :

- Short beak
- Nails taken care of
- Health of the bird

Impression :

- Cleanliness of the cage
- Well-being of the bird

Stamm Definition

To be recognized as a stamm of color canary or type canary, the 4 birds that form it will have to be of the same breed, variety and type and be absolutely identical between them at the level :

- **The background color, including the difference between intensive and non-intensive (or mosaic).**
- **The melanin color (classic or mutation have to be the same in the 4 birds).**
- **Sex (if visible dimorphism)**

In case of non-conformity, each bird will be judged normally, but no harmony will be awarded.

Only the total sum of points for the four birds will be recorded, but whatever the result, the stamm will not be awarded a medal.

In posture canaries, although the above mentioned basilar uniformity requirements are maintained, the following are accepted in stamm.

- **Lipochrome stamm :**
 - A stamm composed only of pure lipochrome birds (no melanin spots will be tolerated)
- **Melanin stamm :**
 - A stamm composed only of pure melanin birds (no lipochrome spots will be tolerated).



- **Variegated stamms :**
- All shapes of variegation are accepted in 1 stamm if the 4 birds presented have more or less the same proportions of variegation so that they look alike. (A stamm must be as uniform as possible).

Exceptions are the Lancashire, the Rheinländer and the lipochromes German Crested, where the melanin is limited in the crest. For melanin German Crest, they must be 100% melanin, including the crest. The Lizard, where the location of the melanin is well defined on the body, beak and legs. In this case, the type of “cap” design must be respected: all with the “Clear or almost clear cap”, or all with the “broken cap”, or all with the “Non cap or almost non cap”.

Melanin is accepted in the beak, feet, toes and nails of lipochromes except for German Crest, Lancashire and Rheiländer.

For lipochromic canaries the melanin plumage is limited to the crest.

Will be accepted :

In stamm :

- **Lipochrome stamm** : 100% lipochrome.
- **Melanin stamm** : 100% melanin.

Only melanin spots in lipochromes and lipochromic spots in melanins on legs, beak and nails will be accepted. The exception are the Lancashire and Rheinländer. Also the German Crested where the color is judged according to the criteria of the color canaries.

Lipochrome variegation in the crest of melanin crested canaries will be considered variegated canaries.

- **Variegated stamm :**

All forms of variegation are accepted in stamm, as long as all 4 birds have the same proportion of variegation. They must also have the same melanin and the same background color.

If melanin spots are only found in the crest of crested canaries, these will be considered as 100% lipochrome.

These rules are also valid for birds exhibited in individual classes.



Harmony

General considerations :

A stamm is composed of 4 (four) subjects which, as part of the competition, must be of the same phenotype "Type, Category, Variety, Sex".

If the judge does not find these considerations, he must in any case judge all the subjects, which will not be considered as a stamm and therefore will not give points of harmony to this stamm and will be excluded from the competition.

Harmony: 6 points available.

The harmony of a stamm is defined by 6 points minus the difference between the subject with the highest points and the lowest points.

DESCRIPTION	Harmony Points
Identical Points Of the four subjects.	6
Difference of 1 point Between the subject with the highest points and the lowest points.	5
Difference of 2 points Between the subject with the highest points and the lowest points.	4
Difference of 3 points Between the subject with the highest points and the lowest points.	3
Difference of 4 points Between the subject with the highest points and the lowest points.	2
Difference of 5 points Between the subject with the highest points and the lowest points.	1
Difference of 6 points or more Between the subject with the highest points and the lowest points.	0

Criteria for Non Judgement

Criteria for Non judgement (NJ):

- Partial or total lack of a limb, one or more toes, one or more nails.
- Deformed foot(s), stiff toe(s).
- One-eyed or blind.
- Significant lack of rectrices and/or remiges.
- Presence of melanin (except in the crest) in Lancashire, Rheinlander or in lipochrome German Crest.
- Presence of lipochrome feathers in the Lizard (except in the cap) or in the German Crest melanin.
- Presence of one or more white nails in a Lizard or in a Black German Crest melanin.
- Presence of artificial pigmentation in breeds where that is not allowed.
- Obvious presence of plumage cyst ("lumps").
- Atypical bird.
- Injured and/or sick subject.
- Any subject with combination of several breeds.
- Any cases not included or not provided for above will be submitted to the Control Commission.

Criteria for Wrong Class

Criteria for Wrong Class (Declassé - DC):

Any bird presented for judgment in the wrong class must be downgraded (DC). It will be necessary for the judge to indicate the right class in which the bird should have been registered.

The bird is judged on the basis of the criteria of the right class where it should have been registered.

The bird in this situation, even if it has an assigned rating, will not receive any award.

If one or more birds are in the wrong class in a stam, then they are not considered a stam.

All birds will be judged, there is no total rating referring to the stam nor the note of the harmony of the stam, there are only the individual notes of the birds (in the judgment sheet must be indicated the correct class of the bird/s registered incorrectly).

In the event that all the birds of the stam are of the same class and are incorrectly registered in another class, they actually constitute a stam and the final notation of the stam is added as well as the harmony, but they will be considered wrong class (DC).

In both cases, regardless of the final rating, no prize will be awarded to these birds.



Criteria for Disqualification











Any indication in the bird or in the cage that is relevant to be understood as a situation of manipulation or attempt to identify that bird. The bird will not be judged and the acronym - DQ (disqualified) will be placed on the judgment sheet.

Criteria for Disqualification (DQ):







- Whenever a sign or marking of a bird or of a cage is visible. For example: bird with more than one ring, absence of the ring, ring with irregularity (open, unofficial, etc.)
- Any exogenous alteration/manipulation of the bird that involves tampering with its characteristics influencing its competitiveness. For example, feathers handled, glued, cut and/or painted.

BREED AND COUNTRY OF ORIGIN

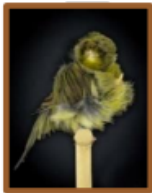
ENGLAND

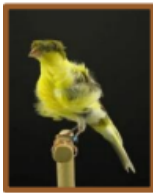
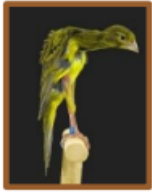
Scotch Fancy 	Border 	Fife Fancy 
Norwich 	Yorshire 	Gloster 
Crest 	Lancashire 	Irish Fancy 
Lizard 	London Fancy 	

ITALY

AGI 	Padovan 	Fiorino 
Gibber Italicus 	Salentino 	Rogetto 
Benacus 		

SPAIN

Raza Española 	Giboso Español 	Melado Tinerfeño 
Llarguet Español 	Giraldillo Sevillano 	

GERMANY

Munichois

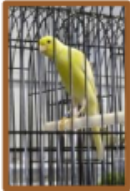

Huppé Allemand



Mehringer

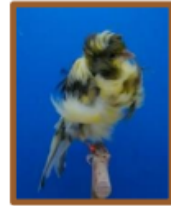

Rheinländer



FRANCE

Parisian Frill



North Frill

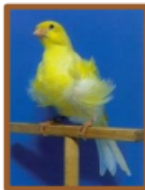

South Frill



SWITZERLAND

Swiss Frill

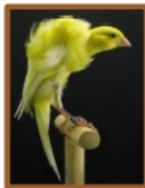

Bernois



BELGIUM

Belgian Bossu



JAPAN / BELGIUM

Japan Hosoi



PORTUGAL

Portuguese Harlequin

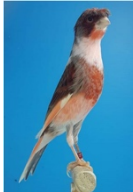

IRAN

Rasmi



**STANDARDS O.M.J. / C.O.M. OF
TYPE CANARIES
E1**



Portuguese Harlequin

Standard

Points	Descriptions
Body (shape) Chest/Wings 20	Elongated body, slender with slightly visible shoulders. Chest slightly rounded. Back narrow, straight, in line with the tail. Long wings, well adhered to the body and without crossing or drooping.
Crest / Head / Neck 15	The Crest (Crested Harlequin) - triangular shape (2 angles behind and 1 virtual in front) radiating from a central point at the top of the cap and dropping, adherent and symmetrically, without covering the eyes and beak. Head (Non-crested Harlequin) – Head narrow, elongated, wider behind than in front. Strong and proportionate beak. Bright and clearly visible eyes. Well-defined and harmonious neck, making the head clearly stand out of the body.
Size 15	16 cm / 6.3 inches.
Color 15	Balanced variegated with the simultaneous presence of red and chalk white lipochrome, having bright red in the characteristic areas of the mosaic red factor. The resulting sexual dimorphism is characterized by a greater extension of red lipochrome in males than in females. Artificial colouring is mandatory.
Position / Movement 15	Erect and majestic position (60°). Body well raised and head raised. Cheerful birds with agile movements.
Plumage 10	Smooth, compact, silky and well adhered to the body.
Legs and Tail 5	Strong, long and slightly bent legs, preferably variegated. Well visible thighs. Tail long, narrow and slightly bifurcated at the end, preferably variegated.
General Condition 5	Perfect health and hygiene. Vivacity and good adaptation to the show cage.

Technical drawing



Photographs



Judgement Sheet



JUDGEMENT SHEET



	Exhibitor		
	Breeder Number	Ring (s)	Country
Portuguese Harlequin			
Description:	Crested <input type="checkbox"/> Non crested <input type="checkbox"/>	E	Class
Cage number			
Body / Chest / Wings	20		
Crest, Head and Neck	15		
Size 16 cm / 6.3 inches	15		
Color	15		
Position 60° / Movement	15		
Plumage	10		
Legs and Tail	5		
General Condition	5		
Total	100		
Observations :	Total		
	Harmony		
	Total of stamm		
Date :	Location :		
Judge :	Classification :		

Show Cage :

Type B (color canary) with 2 round perches separated by 12 cm / 4.72 inches.

Diameter 12 mm / 0.47 of an inch.

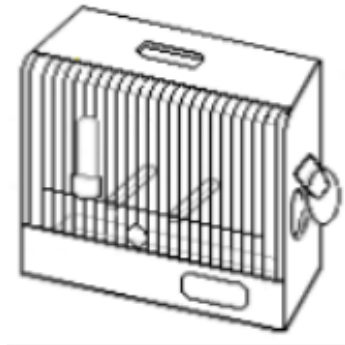

Red mosaic factor.

Artificial coloration mandatory.

German Crest (Deutsche Haube)

Standard

Points	Descriptions
Crest 30	<p>The crest corresponds to the shape of the head, which is oval. It starts from a small and distinct central point.</p> <p>Seen from the side the crest partially covers the beak and extends to the nape of the neck.</p> <p>The passage of the crest into the plumage of the nape of the neck is smooth with no gap.</p> <p>The eyes remain visible.</p>
Color 20	<p>The characteristic of the color is the same as for the Color canaries (are judged according to the respective standard of the color canaries). No variegation is allowed.</p> <p>Lipochromes can have a lipochromic, dark, grizzled crest.</p> <p>The presence of pigment in the crest of lipochromes cannot exceed the limit of the nap of the neck which is characterized by an imaginary straight line that passes between the mandibles and the eye.</p>
Type and Size 15	<p>The shape and type of the bird are identical to those of the color canaries.</p> <p>The wings, well adhered to the body without crossing each other.</p> <p>The size is 13.5 cm / 5.31 inches up to 14.5 cm / 5.70 inches.</p>
Plumage 15	<p>Smooth and well adhered to the body.</p> <p>Narrow and slightly forked tail, length according to the length of the bird.</p>
Position 10	<p>Alert, but not worried. Forming a 45° angle.</p>
General condition 10	<p>The bird is clean and shows itself in good condition.</p>

Technical drawing

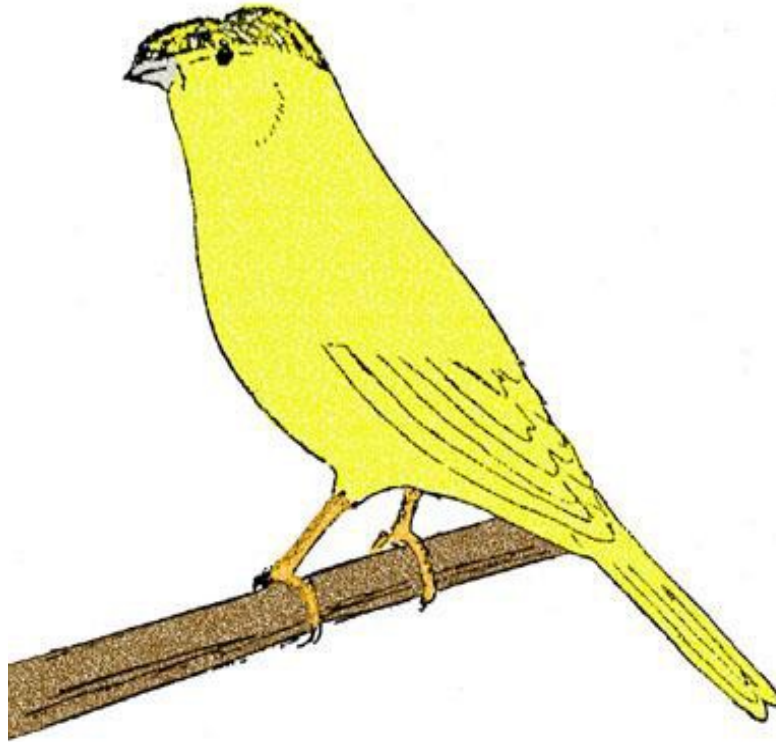

On the red line the melanin is out of the crest.

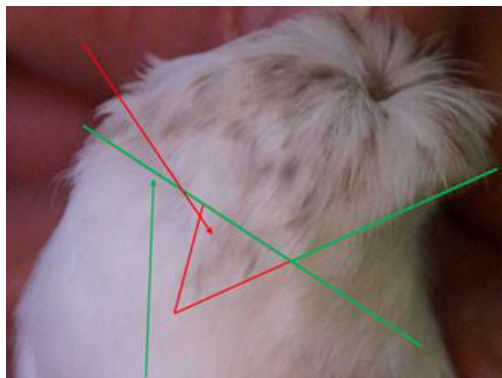



The green line is the delimitation of the authorized presence of melanin in the crest on lipochromic german crest.

Photographs

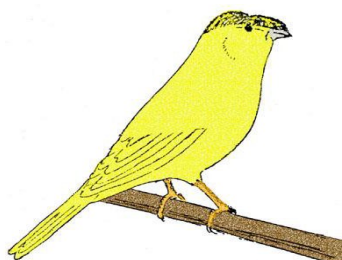

Judgement Sheet

	JUDGEMENT SHEET			
	Exhibitor			
	Breeder Number	Ring (s)	Country	
German Crest				
Description:			E	Class
Cage number				
Crest	30			
Color	20			
Type and Size	15			
Plumage	15			
Position	10			
General Condition	10			
Total	100			
Observation :		Total		
		Harmony		
		Total of stamm		
Date :		Location :		
Judge :		Classification :		

Show Cage :

Type B (color canary) with 2 round perches separated by 12cm / 4.72 inches.

Diameter 12 mm / 0.47 of an inch.



The color characteristics are the same as the color canaries.

In the lipochromes the presence of melanin is only allowed in the crest.



Irish Fancy

Standard

Points	Descriptions
Head 20	Small, narrow and neat. Rising slightly from a small beak. Good clear eyes.
Body 20	Shoulder width: 3.3 cm / 1.9 inches. Spindle-shaped body, well proportioned. Wings well adherent to the body. Visible neck.
Plumage 15	Well closed and compact. Giving a clear appearance of natural colour. Show distinct and clear outlines.
Movement and Position 15	Alert, with quick, likely movements. Position on the perch from 65° to 75°.
Size 10	Size 12.5 cm / 4.92 inches to 13 cm / 5.11 inches maximum.
Tail 10	Closed and well carried.
Legs and Feet 5	Average length. Visible thighs.
General Condition 5	Healthy and clean. All colors are allowed, except red. Coloring food is not allowed.

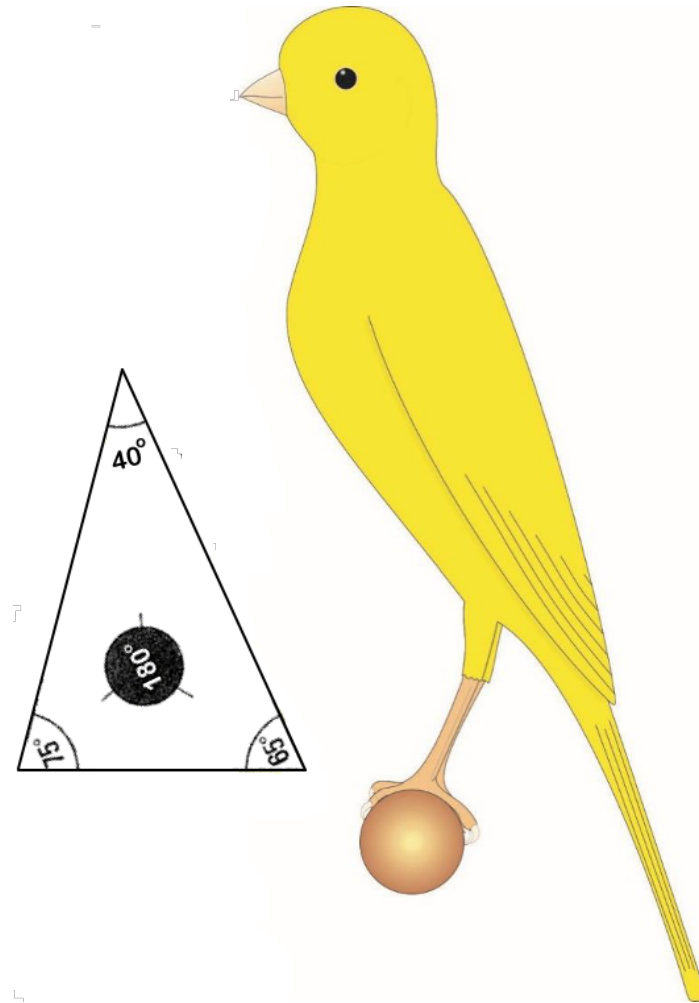

Technical drawing



Photographs



Judgement Sheet

	<h2 style="margin: 0;">JUDGEMENT SHEET</h2>				
	Exhibitor				
	Breeder Number		Ring (s)		Country
Irish Fancy					
Description:				E	Class
Cage number					
Head	20				
Body	20				
Plumage	15				
Movement and Position	15				
Size	10				
Tail	10				
Legs and Feet	5				
General Condition	5				
Total		100			
Observation :		Total			
		Harmony			
		Total of stamm			
Date :		Location :			
Judge :		Classification :			

Show Cage :

Type B (color canary) with 2 round perches separated by 12cm / 4.72 inches.

Diameter 12 mm / 0.47 of an inch.

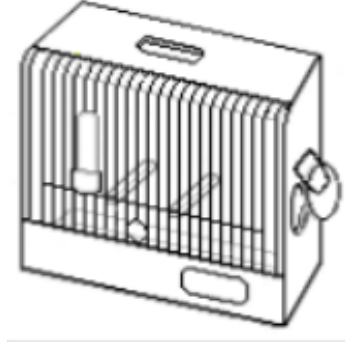

All colors are allowed except red.

Lizard

Standard

Points	Descriptions
Dorsal design (Spangles) 30	<p>The design of the back is formed by small scales, in the shape of a half-moon, perfectly aligned and separated from each other, enlarging towards the base of the wings.</p> <p>It is highlighted, with the background color that appears between each design. The spangles are dark as possible.</p> <p>Eumelanin should be oxidized (as black as possible). The presence of brown is to be penalized. The design must be visible in the broken part of the cap.</p>
Chest design (Rowings) 15	<p>The chest design is slightly more attenuated and wider. Drawn from the underside of the beak to the base of the tail, the rowings remain clearly visible, aligned and increasing in size towards the belly and flanks.</p>
Cap and Eyelash 15	<p>a) The clear cap has an oval shape and starts above the upper mandible, passes over the eye and stops at the base of the skull. Its color is the background color without any spots inside.</p> <p>Up to 10% melanin is allowed in the border of the cap (Nearly clear cap).</p> <p>b) The broken cap shows one or more pigmented parts having the typical design of spangles and are the narrowing extension of the back design.</p> <p>c) The non cap have the design of the back that continues in a tapering fashion over the entire surface of the cap.</p> <p>Up to 10% lipochrome is allowed in the head (Nearly non cap).</p> <p>Note that all Lizards caps are equally rated according to the standard. This is valid for gold, silver or blue, colored or not.</p> <p>Also for clear cap, broken cap or non cap, male or female. Birds with a broken cap are equal for the standard and can only lose a few points in relation to the 10 points provided.</p> <p>The perfection of the design in the broken parts, will be mainly taken into consideration.</p> <p>Eyelashes: form a line of black feathers that separates the eye and accentuates the oval shape of the cap.</p>
Feather quality 10	<p>Very shiny, perfectly adherent to the body and not rough at all.</p>
Ground Colour 10	<p>Yellow, white or red.</p> <p>The ground colour is regular and uniform. Golden yellow for intensive and straw yellow for silver.</p> <p>The non-intensive effect must be very well distributed.</p> <p>Red coloring allowed. The darker the better.</p> <p>The blue lizard, it exists as a dominant color and so the eumelanine is dispersed in the plumage and mixes with the white ground colour giving a tight and relatively short bluish-gray impression.</p>

Beak, Legs and Nails 10	They should be as black as possible. Light colored beak, legs and nails are penalized.
Covert feathers (Lacings) 5	Covert feathers: form typical black lace borders that cover the base of the wing feathers, separated from each other.
Wings and tail 5	Wings and tail: The tail and wing feathers are as black as possible. Tail tight and relatively short. Wings well adhered to the body.
Size and presentation 5	Alert and lively. Good presentation. Size 13.5 cm / 5.31 inches.

Technical drawing

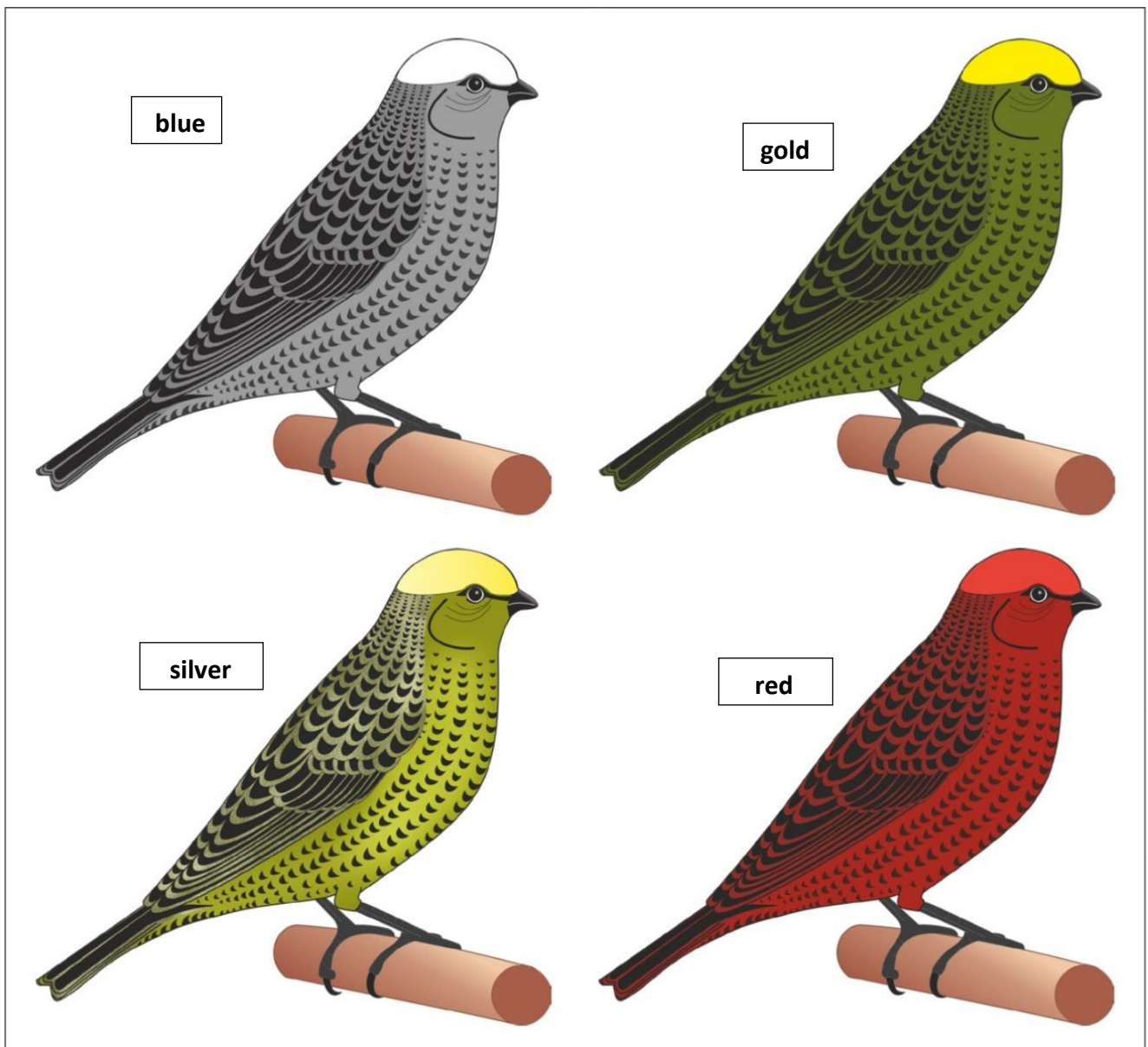

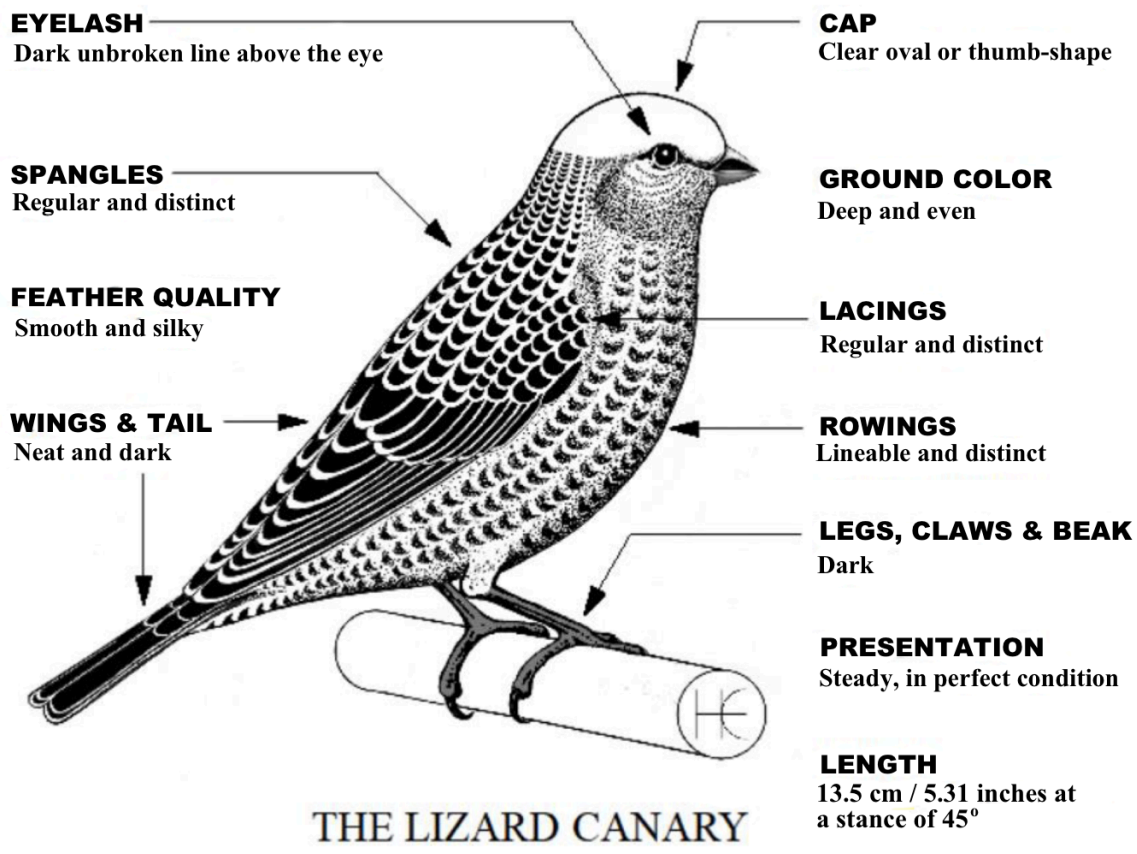



Photographs



Judgement Sheet

	JUDGEMENT SHEET							
	Exhibitor							
	Breeder Number	Ring (s)	Country					
Lizard								
Description:	Blue Clear cap		Gold Broken cap		Silver Non cap		E	Class
Cage number								
Dorsal design (Spangles)	25							
Chest design (Rowings)	15							
Cap and eyelash	15							
Feather quality	10							
Ground Colour	10							
Beak, Legs and Nails	10							
Covert feathers (Lacings)	5							
Wings and tail	5							
Size and presentation 13,5 cm	5							
Total	100							
Observation :			Total					
			Harmony					
			Total of stamm					
Date :			Location :					
Judge :			Classification :					

Show Cage :

Type B (color canary) with 2 round perches separated by 12cm / 4.72 inches.

Diameter 12 mm / 0.47 of an inch.

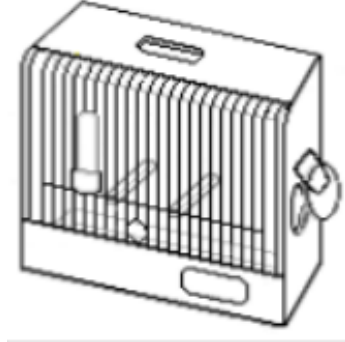

Ground Colors: yellow, white or red.

London Fancy

Standard

Points	Descriptions
Head and Body 25	The head and body should display the ground colour free, or almost free, from melanin (the smaller and fewer the better).
Wings and Tail 20	All wing feathers should be present and held closely to the body. The wing tips should meet along the center of the back. The wing feathers are so dark as to appear almost black. The tail is narrow and neat, with all feathers present and of the same colour as the wings.
Wing covers 15	The greater covert feathers and the alulas at the wing butts should be the same colour as the wings. They combine with the tertiaries to form a dark crescent shape that contrasts against the clear body.
Ground Colour 15	The ground colour must be rich, deep and even. Intensive birds should display a luminous quality, non-intensive a softer, paler effect. White ground colour should be free from a yellow tinge. Colour feeding is not permitted.
Feather quality 10	The plumage should be fine, forming smooth flowing contours to the body with no suggestion of coarseness or looseness.
Legs, Nails and Beak 5	The legs, toes, nails and beak should be as dark as possible.
Size 5	Length 13.5 cm / 5.31 inches with a stance of 45°. A wide head and broad shoulders are an advantage.
Condition 5	The bird should be steady, confident and in excellent health.

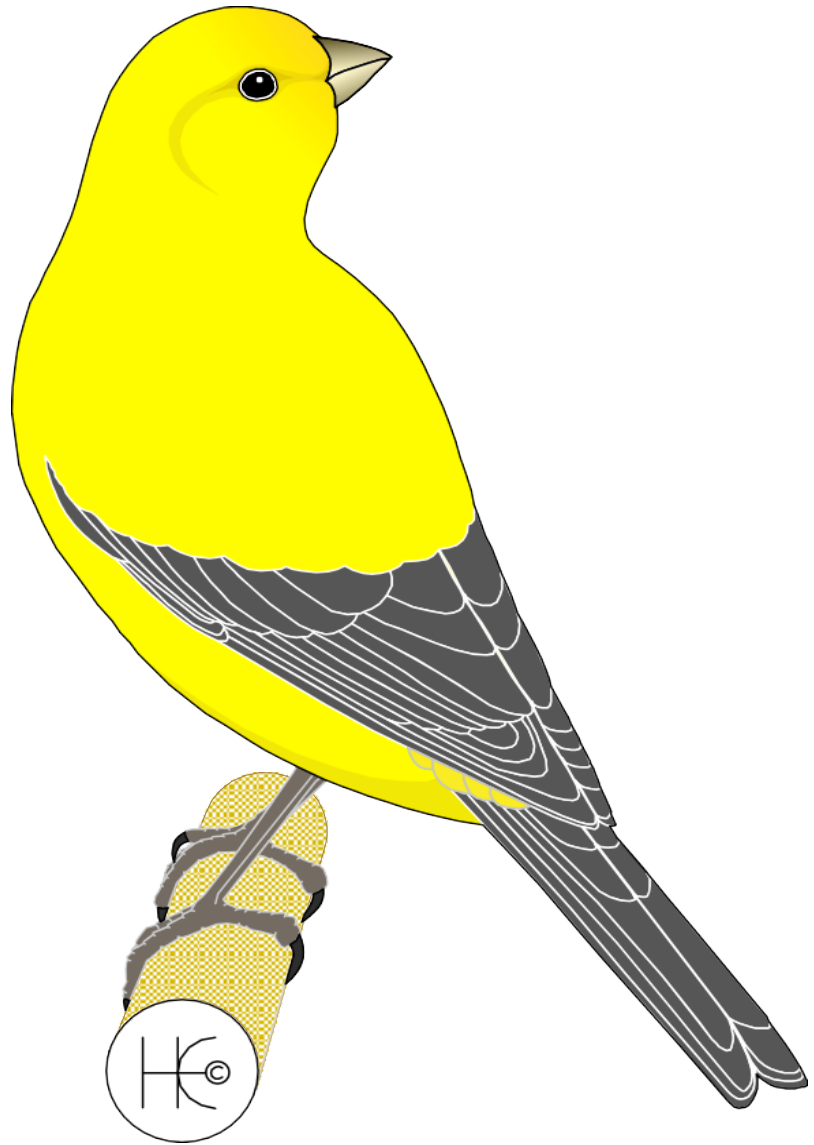

Technical drawing



Photographs

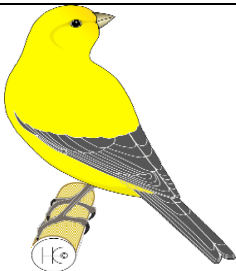

Judgement Sheet

 <p>C.O.M. CONFÉDÉRATION ORNITHOLOGIQUE MONDIALE</p>	<h2 style="margin: 0;">JUDGEMENT SHEET</h2>			 <p>O.M.J. CONFÉDÉRATION ORNITHOLOGIQUE MONDIALE</p>
	Exhibitor			
	Breeder Number	Ring (s)	Country	
London Fancy				
Description:			E	Class
Cage number				
Head and Body	25			
Wings and Tail	20			
Wing Coverts	15			
Ground Colour	15			
Feather quality	10			
Legs, Nails and Beak	5			
Size	5			
Condition	5			
Total	100			
Observation :		Total		
		Harmony		
		Total of stamm		
Date :		Location :		
Judge :		Classification :		

Note : We have the admission of the London Fancy with 1 and 2 years in the currently existing classes (intensive, schimmel and white background). Birds aged 1 and 2 years compete together.

Show Cage :

Type B (color canary) with 2 round perches separated by 12cm / 4.72 inches.

Diameter 12 mm / 0.47 of an inch.



**Ground Colors: yellow, white.
Red color is not allowed.**

Gloster

Standard

Points	Descriptions
Size 20	The small as possible (max. 11 cm / 4.33 inches).
Corona Consort 20	<u>Corona</u> : very round and full. Adherent in the neck. Central point in the middle of the head and as small as possible. Eye still visible. <u>Consort</u> : very round and broad, eyebrows well marked, full cheeks. Beak conical and small.
Body 20	Back well filled, slightly rounded. Wings well closed. Chest very broad, round and stocky without prominence. Full neck, invisible when head ends and body begins.
Plumage 20	Close, firm, shiny and natural color.
Position 5	Proud. Semi-erect. Lively movement.
Tail 5	Short, narrow, at the same inclination as the back.
Legs and thighs 5	Short legs, slightly bent. Not visible thighs.
Condition 5	Healthy. Not damaged, clean. All colors are allowed, except red.

Technical drawing

Gloster corona

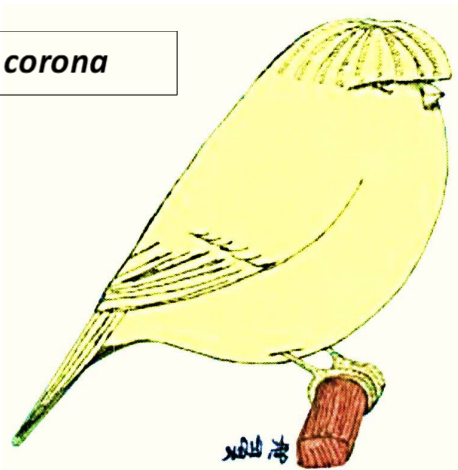

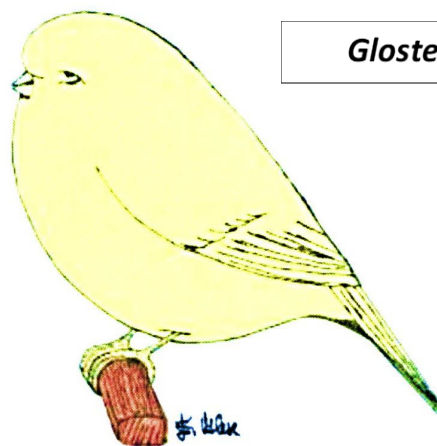

Gloster consort



Photographs

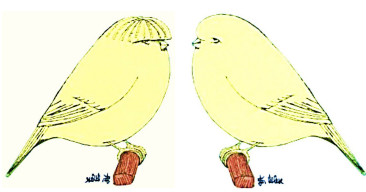

Judgement Sheet

 <p>C.O.M. CONFÉDÉRATION ORNITHOLOGIQUE MONDIALE</p>	JUDGEMENT SHEET			 <p>O.M.J. CONFÉDÉRATION ORNITHOLOGIQUE MONDIALE</p>
	Exhibitor			
	Breeder Number	Ring (s)	Country	
Gloster				
Description :		Corona <input type="checkbox"/> Consort <input type="checkbox"/>	E	Class
Cage number				
Size (11 cm / 4.33 inches)	20			
Corona - Consort	20			
Body	20			
Plumage	20			
Position	5			
Tail	5			
Legs and thighs	5			
Condition	5			
Total	100			
Observation :	Total			
	Harmony			
	Total for stamm			
Date :		Location :		
Judge :		Classification :		

Show cage :

Type C4 « Gloster » with 2 oval perches spaced 7.5 cm / 2.95 inches apart.

Diameter 12 x 9 mm – 0.51 x 0.35 of an inch.

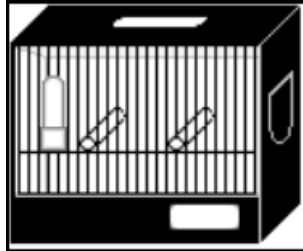

Or failing that in cage type B « Color canary »

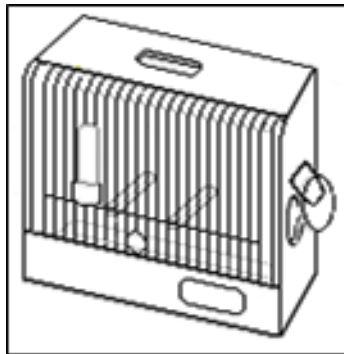

All colors are allowed except red.

Crested/Crestbred

Standard

Points	Descriptions
Crest (Crested) Head (Crestbred) Beak Eyebrows 50	<p><u>Crest</u> : Large and perfectly round, proportionally distributed around a small central point. The feathers of the crest are abundant, long, wide and cover the eye, part of the beak and the back of the head.</p> <p>A crest can never be consider too big. A drooping crest will always have preference.</p> <p><u>Head</u> : Broad and round in all directions. Long and abundant feathers start from the base of the beak and completely cover the skull to fall on the back of the head. A good crestbred head feather must, if turned over, reach the tip of the beak.</p> <p><u>Beak</u> : Short.</p> <p><u>Eyebrows</u> : heavy and drooping.</p>
Plumage, Tail Wings, color 25	<p>An abundance of feathers but without frills. Short and narrow tail. The wings cannot exceed the base of the tail. Rooster feathers on either side of the tail. All colors are allowed except red.</p>
Body, Syze 15	<p>The shape of the Bullfinch. Not stocky. ± 17 cm / 6.7 inches, well filled chest.</p>
Legs - Thighs 5	<p>Short legs with elbows and thighs well set back.</p>
Condition 5	<p>Healthy, clean and accustomed to the cage.</p>

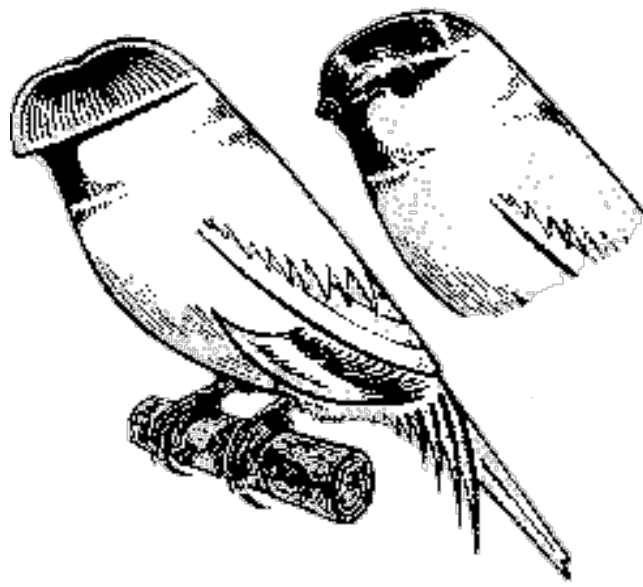

Technical drawing



Photograph

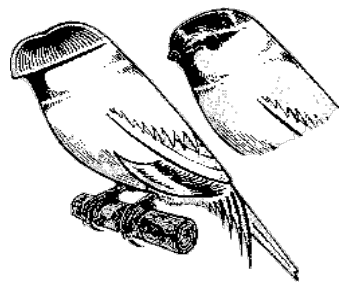

Judgement Sheet

 <p>C.O.M. CONFÉDÉRATION ORNITHOLOGIQUE MONDIALE</p>	<h2 style="margin: 0;">JUDGEMENT SHEET</h2>			 <p>O.M.J. CONFÉDÉRATION ORNITHOLOGIQUE MONDIALE</p>
	Exhibitor			
	Breeder Number	Ring (s)	Country	
Crested/Crestbred				
Description:	Crested <input type="checkbox"/>	Crestbred <input type="checkbox"/>	E	Class
Cage number				
Crest (Crested)	50			
Head and Neck (Crestbred)				
Beak and Eyebrows				
Plumage, Tail, Wings and Color	25			
Body, Size	15			
Legs and Thighs	5			
Condition	5			
Total	100			
Observation :	Total			
	Harmony			
	Total for stamm			
Date :	Location :			
Judge :	Classification :			

Show cage :

Type C5 « Crest » with 2 oval perches spaced 12 cm / 4.80 inches apart.

Diameter 13 x 9 mm / 0.35 x 0.51 of an inch.

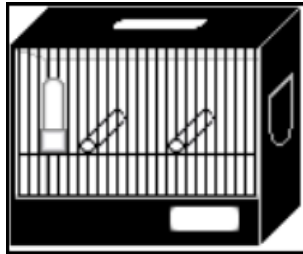

Or failing that in cage type B « Color canary »

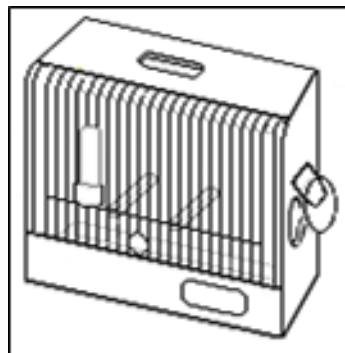

All colors are allowed except red.

Norwich

Standard

Points	Descriptions
Shape – Type Presentation Size 25	Short and stocky body, with full and broad chest. Wide and full back. The rather large chest-back distance brings out a ball effect. Not too erect, not too reclining, phlegmatic carriage. Position : 45° angle. Size : 16 to 16,5 cm / 6.35 to 6.5 inches.
Plumage 20	Rich, full, tight and shiny, necessary to have the contours well pronounced.
Nap and Neck 10	The neck is short, full and broad without no retouching. Also very full in the throat.
Head 10	The head is round, heavy and full. The front of the forehead is full and wide. Chubby cheeks. The beak is short and conical. The eyes are well placed in relationship of the beak and remain visible.
Wings 10	Short wings well-adhered to the body.
Color 10	All colors are allowed, including orange - red. Rich and brilliant color.
Tail 5	Short and tight tail in relation to the whole bird, well placed in the axis of the body.
Legs and Thighs 5	Neither too long nor too short, robust. The thighs are visible only when the bird is moving.
Condition 5	Healthy, without defects or deformities.



Technical drawing



Photograph

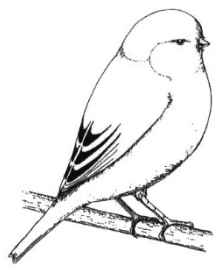

Judgement Sheet

	<h2 style="margin: 0;">JUDGEMENT SHEET</h2>				
	Exhibitor				
	Breeder Number		Ring (s)		Country
Norwich					
Description :				E	Class
Cage number					
Shape – Type	25				
Presentation					
Size					
Plumage	20				
Nap and Neck	10				
Head	10				
Wings	10				
Color	10				
Tail	5				
Legs and Thighs	5				
Condition	5				
Total		100			
Observation :		Total			
		Harmony			
		Total for stamm			
Date :		Location :			
Judge :		Classification :			



Show cage :

Type C6 « Norwich » with 2 oval perches spaced 9 cm / 3.54 inches apart

Diameter 13 x 9 mm / 0.51 x 0.35 of an inch

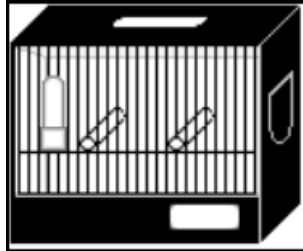

Or failing that in cage type B « Color canary »

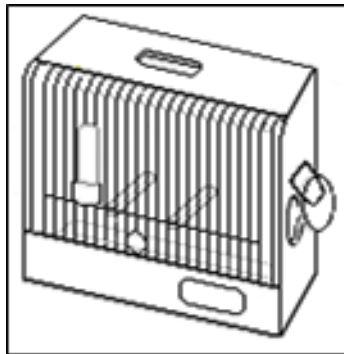

All colors are allowed including red (orange)

Rasmi

Standard

Points	Descriptions
Position 20	Graceful posture, from head to the end of tail forming a straight line. Consistent and robust appearance. Position of the body forms a 50° angle with a horizontal line. Complete harmony between all parts of the bird.
Size 20	Size 21 cm / 8.25 inches minimum. The goal is to enlarge the size updating the standard.
Tail 20	The long tail is in extension with the body, and clearly on a straight line with the back. The end of the tail width should not be smaller than the shoulders width. The length of the tail must be in proportion with the body length.
Body, Wings & Plumage 15	Long, elongated body with well implanted shoulders attached to the body. Long wings covering at least 1/3 of the tail. Primary flights aligned and regular. The tips of the wings joining in the upper part of the tail without crossing. Plumage smooth, neat, solid and semi-long.
Head & Neck 10	Round and slightly flat head in the upper part of the skull and proportional to the body. Short conical beak. Well marked neck, not too big or too short. Round eyes with no eyebrows.
Legs 10	Strong and firm legs. The thighs are long and visible. Feathered thighs.
Condition 5	The bird should be healthy, vibrant and active. All colors are allowed except red factor.

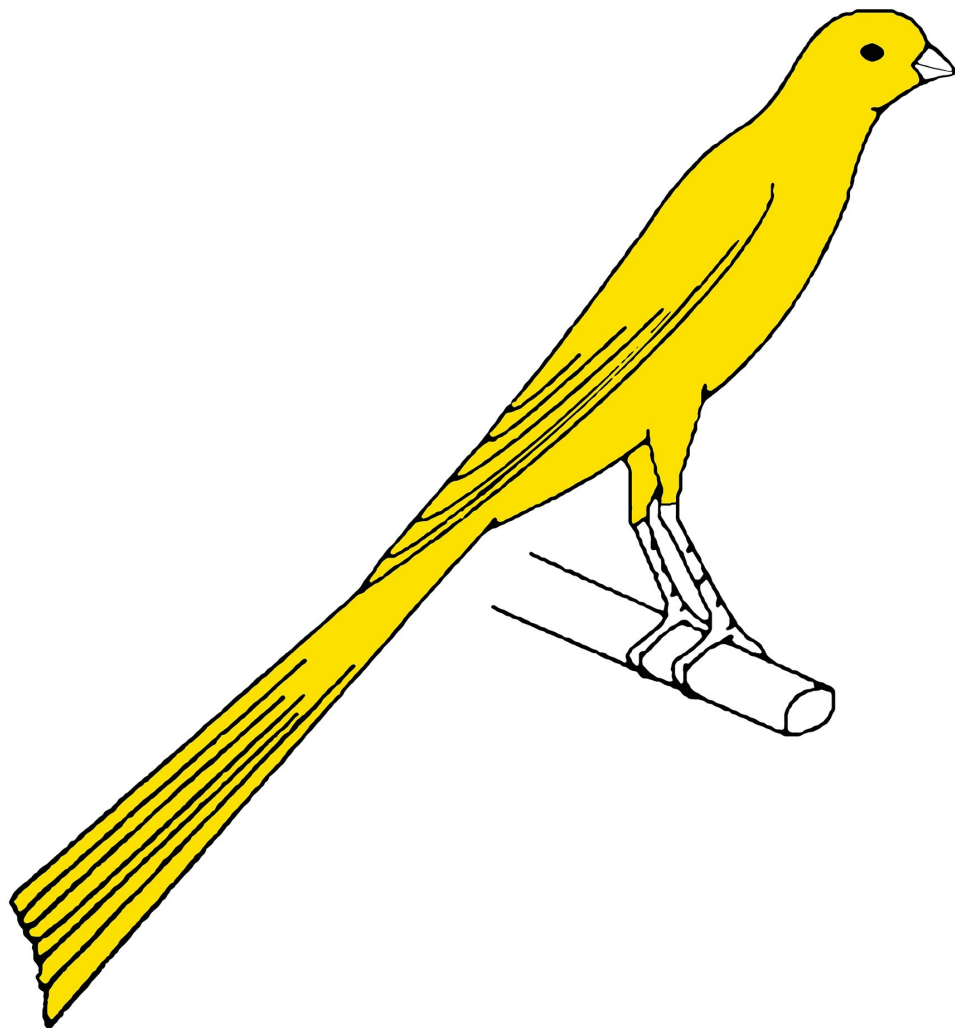

Technical drawing



Photographs

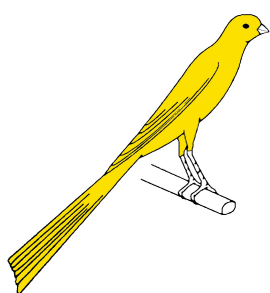

Judgement Sheet

	JUDGEMENT SHEET			
	Exhibitor			
	Breeder Number	Ring (s)	Country	
Rasmi				
Description :			E	Class
Cage number				
Position	20			
Size	20			
Tail	20			
Body, Wings & Plumage	15			
Head & Neck	10			
Legs	10			
Condition	5			
Total	100			
Observation :		Total		
		Harmony		
		Total for stamm		
Date :		Location :		
Judge :		Classification :		

Show cage :

Type C1 « Parisian Frill » with 2 round perches spaced 12 to 13 cm / 4.72 to 5.1 inches apart

Diameter 12 mm / 0.47 of an inch

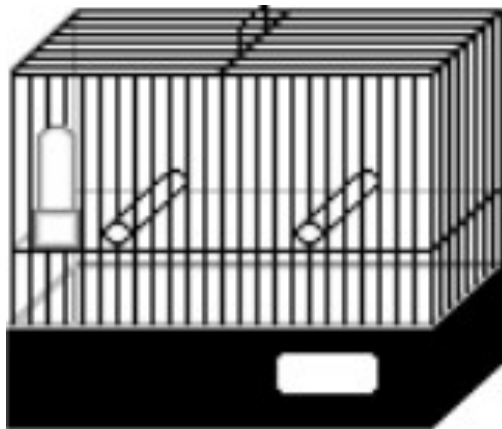

All colors are allowed except red.

Border

Standard

Points	Descriptions
Position and Carriage 15	Gay, jaunty, with full poise of the head standing at an ideal angle of 60°.
Body 15	The profile when viewed to the side will have a well filled and rounded body showing no heaviness with a curve to the chest and back in harmony running in a straight downward curve to the root of the tail. Viewed from above the shoulders shall be in balance with the depth of body showing a nicely rounded bird from all angles. Splits in the chest feathering to be avoided.
Color 15	Rich, soft and pure, as level in tint as possible throughout, but extreme depth and hardness such as color feeding gives are debarred. Any exhibit showing the effects of colour feeding will be disqualified.
Head and Neck 10	Head well rounded and neat when viewed from any angle, beak fine. Eyes clear and positioned to rest on an imaginary line drawn as an extension to the line between the upper and lower mandible of the beak, very slightly forward of a central point of of the head. Neck in keeping with the head, showing a distinguishing break between head and shoulders. The size of the head should be in balance with the body. Cuts or openings in the feathering between the head and the body should be avoided.
Wings 10	Compact and carried close to the body, covering the back, with a full compliment of primary and secondary flight feathers meeting at the tips. Outer flight tips to meet at the root of the tail. Primaries and secondaries to be pointed.
Plumage 10	Close, firm and fine in quality, presenting a smooth, silken glossy appearance, free from browiness, frill or roughness and cuts or splits in the chest and neck feathers.
Health and Condition 10	Condition and cleanliness shall be essential.
Legs and Feet 5	Must be of sufficient length and showing thigh all in harmony with the size of the bird allowing it to adopt a gay jaunty stance. Feet in keeping with the legs, both to be clean and without blernish.
Tail 5	Close packed and narrow, being nicely rounded and well filled in at the root.
Size 5	The ideal length from the top of the head to the tip of the tail is 14.6 cm / 5.75 inches. Length should be in proportion and balance with the other features of the bird.

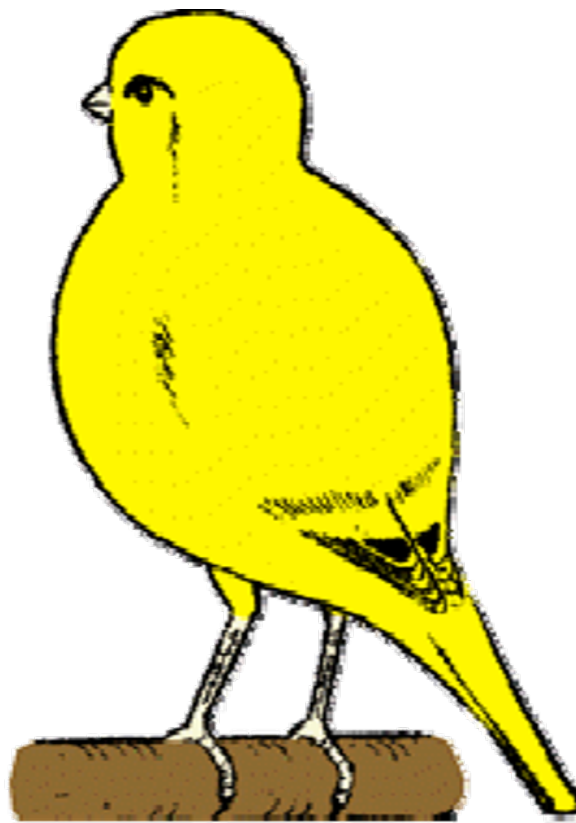

Technical drawing



Photographs

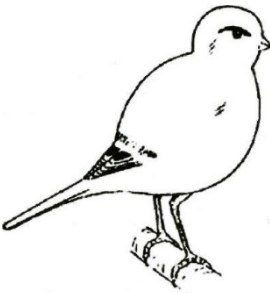

Judgement Sheet

	JUDGEMENT SHEET			
	Exhibitor			
	Breeder Number	Ring (s)	Country	
Border				
Description:			E	Class
Cage number				
Position 60° and Carriage	15			
Body	15			
Colour	15			
Head and Neck	10			
Wings	10			
Plumage	10			
Health and Condition	10			
Legs and Feet	5			
Tail	5			
Size	14,6 cm / 5.75 inches	5		
Total	100			
Observation :		Total		
		Harmony		
		Total for stamm		
Date :		Location :		
Judge :		Classification :		



Show cage :

Type C3 « Border » with 2 perches spaced 10.2 cm / 4 inches apart.

Diameter 14 mm / 0.55 of an inch.

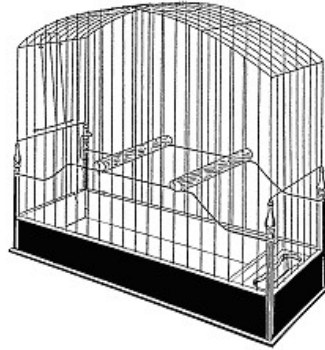

All colors are allowed except red.

Fife Fancy

Standard

Points	Descriptions
Size 20	11 cm / 4.3 inches maximum.
Body and Back 15	Egg-shaped body. Rounded chest, without prominence. Shape of a heart, seen from the front. Round and slightly curved back.
Head and Neck 10	Small and perfectly spherical head. Short, conical beak. Deep neck. Well centered eyes.
Position and movement 10	Proud. Semi-erect 60°. Head raised. Gay, jaunty with graceful movements.
Plumage 10	Smooth. Well adhered to the body. Good quality.
Color 10	Rich, soft and pure color. Artificial colouring prohibited.
Wings 10	Of the length adapted to the body. Joining on the rump without crossing each other.
Legs 5	Short thighs are partially visible. Legs of medium length.
Tail 5	Short and tight, round at the base.
Health and Condition 5	In good condition and healthy, without deformities or other defects.

Technical drawing

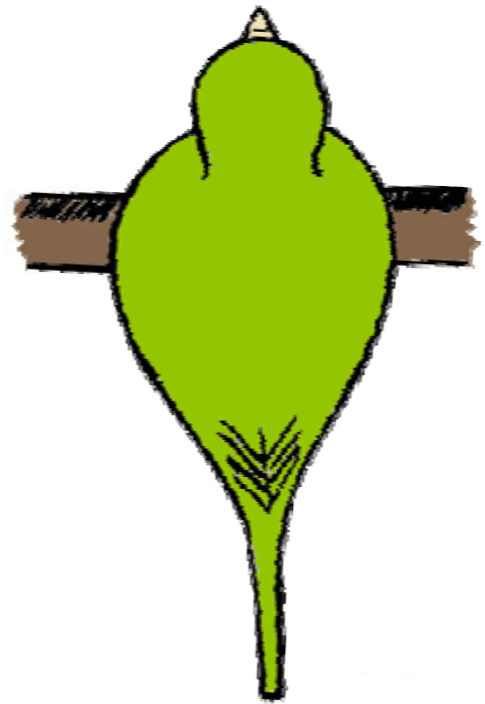
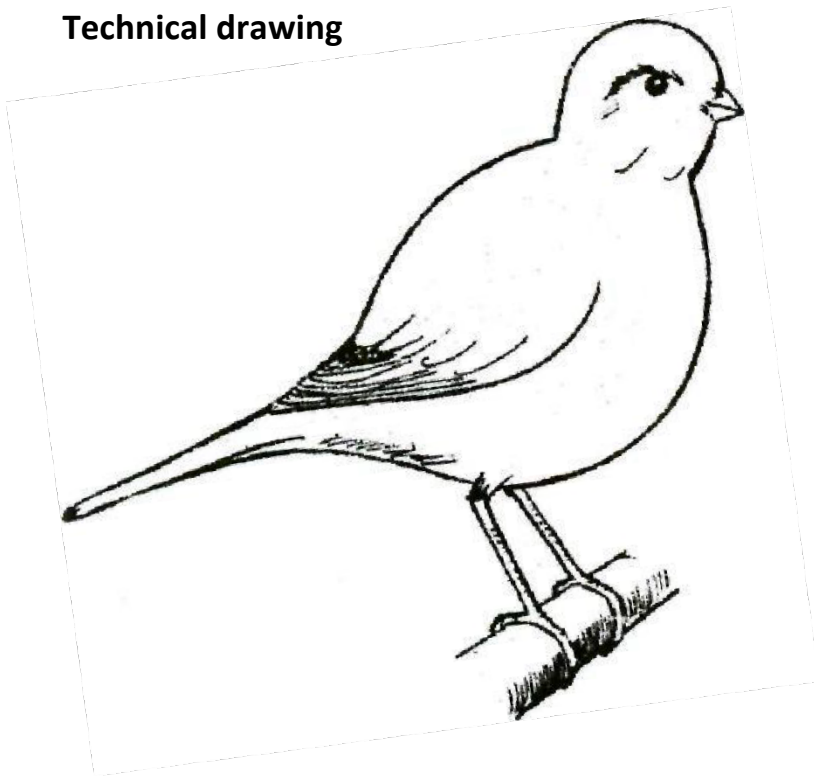

Photograph



Judgement Sheet



JUDGEMENT SHEET

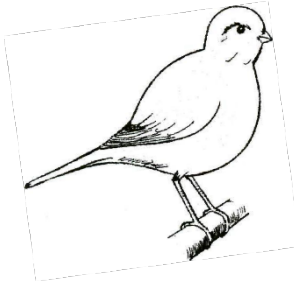

	Exhibitor		
	Breeder Number	Ring (s)	Country
Fife Fancy			
Description:	E	Class	
Cage number			
Size 11 cm. / 4.3 inches	20		
Body and Back	15		
Head and Neck	10		
Position and Movement	10		
Plumage	10		
Color	10		
Wings	10		
Legs	5		
Tail	5		
Health and Condition	5		
Total	100		
Observation :	Total		
	Harmony		
	Total for stamm		
Date :	Location :		
Judge :	Classification :		

Show cage :

Type C3 « Border » with 2 round perches spaced 8.8 cm / 3.5 inches apart
Diameter 12 mm / 0.47 of an inch

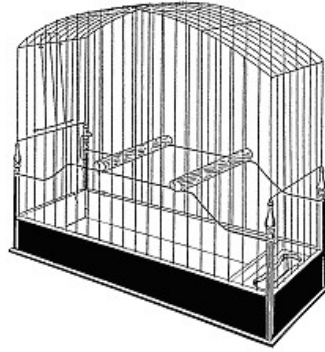

All colors are allowed except red.

Japanese Hosō

Standard

Points	Descriptions
Position (holding) and motion 25	Half-moon shape. Visible thighs. Slightly curved legs. On the move.
Form 20	<u>Body</u> : thin, arched, cylindrical in shape. Frills in the feathers not allowed.
Size 20	11,5 cm. / 4.52 inches max.
Shoulders and Back 15	Shoulders high, narrow and well rounded. No hollow between the shoulders. Well rounded back.
Head and Neck 10	<u>Head</u> : small, oval, serpentine. <u>Neck</u> : long and narrow.
Tail 5	Narrow, as close to the perch as possible. Extension of the curved line of the back. Slightly forked.
Condition and Plumage 5	Healthy. Clean. Smooth plumage. All colors are allowed.



Technical drawing



Photograph



Judgement Sheet

 <p>C.O.M. CONFÉDÉRATION ORNITHOLOGIQUE MONDIALE</p>	<h2 style="margin: 0;">JUDGEMENT SHEET</h2>				 <p>O.M.J. CONFÉDÉRATION ORNITHOLOGIQUE MONDIALE</p>
	Exhibitor				
	Breeder Number		Ring (s)		Country
Japanese Hoso					
Description:				E	Class
Cage number					
Position (holding) and Motion	25				
Form	20				
Size 11,5 cm / 4.52 inches	20				
Shoulders and Back	15				
Head and Neck	10				
Tail	5				
Condition and Plumage	5				
Total	100				
Observation :		Total			
		Harmony			
		Total for stamm			
Date :		Location :			
Judge :		Classification :			

Show cage :

Type C3 « Border » with 2 round perches spaced 8.8 cm / 3.46 inches apart

Diameter 12 mm / 0.47 of an inch

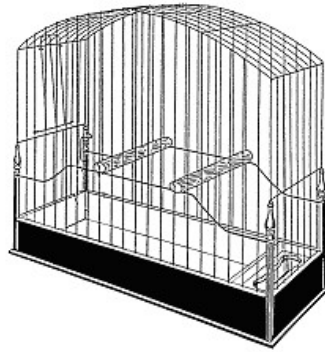

All colors are allowed.

Raza Española

Standard

Points	Descriptions
Size 25	As small as possible. Maximum 11 cm / 4.33 inches.
Shape 25	Narrow and thin back and chest. Without prominence. Cylindrical body. Slightly flattened back.
Head and Neck 15	Small head in form of a hazelnut. Thin and short neck, well cleared from the body. Small and conical beak.
Thighs and Legs 10	Short and flexed legs. Thighs not very visible. Short tarsus (14 mm / 0.55 of an inch) and short toes.
Wings and Tail 10	In proportion to the size of the bird. Well adhered to the body. Wings ending in a point, without crossing. Tail medium length, narrow and slightly forked. (Fish tail).
Plumage 5	Compact and closed. Well adhered to the body.
Position and Action 5	Lively in free and agile movement. Normal position 45°.
Condition 5	Clean, healthy and active. Color: All colors are allowed.

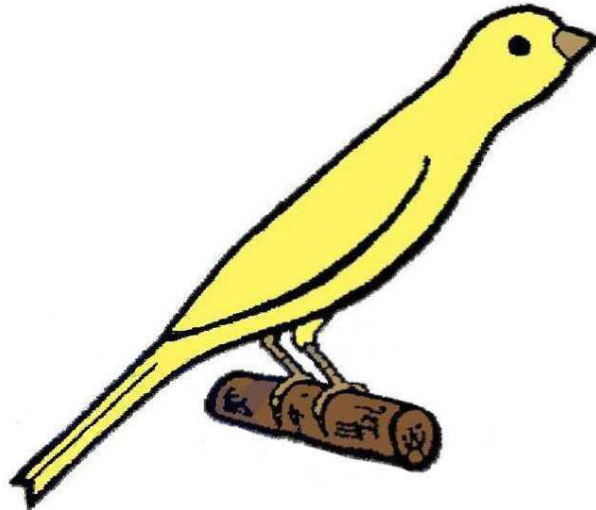

Technical drawing



Photograph



Judgement Sheet

	JUDGEMENT SHEET			
	Exhibitor			
	Breeder Number	Ring (s)	Country	
Raza Española				
Description:			E	Class
Cage number				
Size 11 cm. / 4.3 inches	25			
Shape	25			
Head and Neck	15			
Thighs and Legs	10			
Wings and Tail	10			
Plumage	5			
Position and Action 45º	5			
Condition	5			
Total	100			
Observation :		Total		
		Harmony		
		Total for stamm		
Date :		Location :		
Judge :		Classification :		

Show cage :

Type C3 « Border » with 2 round perches spaced 8.8 cm / 3.46 inches apart

Diameter 12 mm / 0.47 of an inch

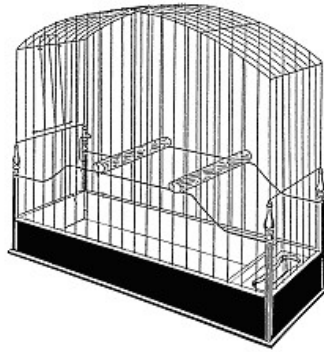

All colors are allowed.

Scotch Fancy

Standard

Points	Descriptions
Position and Motion 25	Half-moon shape. In motion. Legs slightly bent.
Form 20	<u>Body</u> : long, slim and gradually decreasing in cylindrical shape. Short Legs. Convex above and concave below.
Shoulders and Back 20	<u>Shoulders</u> narrow and well rounded. No hollow between the shoulders. <u>Back</u> well rounded, forming an arch.
Head and Neck 10	<u>Head</u> : small, oval. <u>Neck</u> : long and narrow.
Size 10	± 17 cm / 6.7 inches.
General Condition and Plumage 10	Healthy and clean. Smooth plumage. No frills. All colors are allowed, except red.
Tail 5	Long and narrow, as much as possible below the perch. Extension of the curved line of the back.

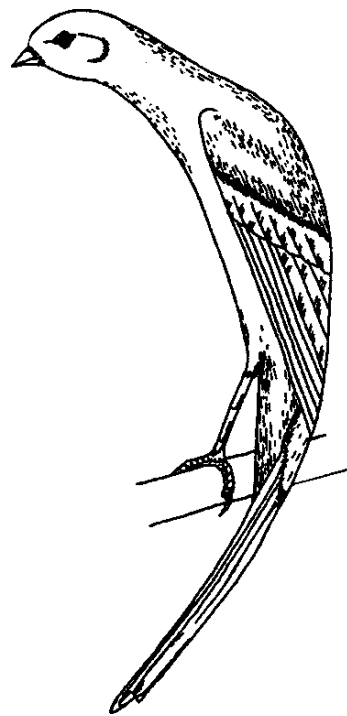

Technical drawing



Photograph



Judgement Sheet

 <p>C.O.M. CONFÉDÉRATION ORNITHOLOGIQUE MONDIALE</p>	<h2 style="margin: 0;">JUDGEMENT SHEET</h2>			 <p>O.M.J. CONFÉDÉRATION ORNITHOLOGIQUE MONDIALE</p>
	Exhibitor			
	Breeder Number	Ring (s)	Country	
Scotch Fancy				
Description:			E	Class
Cage number				
Position and Motion	25			
Form	20			
Shoulders and Back	20			
Head and Neck	10			
Size	10			
Condition and Plumage	10			
Tail	5			
Total	100			
Observation :		Total		
		Harmony		
		Total for stamm		
Date :		Location :		
Judge :		Classification :		

Show cage :

Type C3 « Border » with 2 round perches spaced 10,2 cm. / 4 inches apart

Diameter 12 mm / 0.47 of an inch

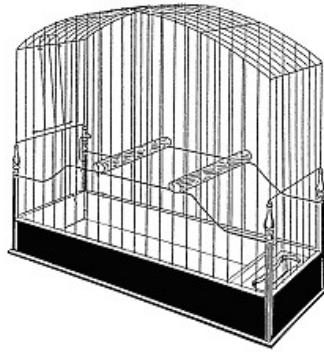

All colors are allowed except red.

Bernois

Standard

Points	Descriptions
Position Presentation Size 25	Fairly erect position. Calm. 16 – 16,5 cm ; 6.3 – 6.5 inches.
Head and Neck 20	Head wide and flat, having forehead. The back of the skull: angular. Neck not too short.
Chest - Shoulders and Body 20	Well filled chest. Visible shoulders (wing attachment). Long and keel-shaped body. Long back.
Wings and Tail 10	Long wings that touch each other without crossing. Long and narrow tail, which forms a line with the back.
Thighs and Legs 10	Half visible thighs, with short feathers. Rather long legs, slightly bent.
Plumage and Color 10	Smooth plumage, tight and well adhered to the body. Uniform or variegated color. The red color is not allowed.
Condition 5	Healthy, without defects and deformities.

Technical drawing

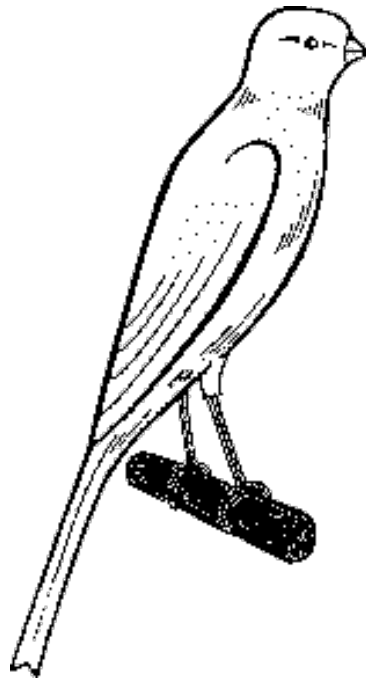

Photograph



Judgement Sheet



JUDGEMENT SHEET



	Exhibitor		
	Breeder Number	Ring (s)	Country
Bernois			
Description:		E	Class
Cage number			
Position, Presentation and Size	25		
Head and Neck	20		
Chest, Shoulders and Body	20		
Wings and Tail	10		
Thighs and Legs	10		
Plumage and color	10		
Condition	5		
Total	100		
Observation :	Total		
	Harmony		
	Total for the stamm		
Date :	Location :		
Judge :	Classification :		



Show cage :

Type C2 « Tunnel » with 2 round perches
(1 top perch in the middle of the cage + 1 bottom perch on the 4th bar from the left).

Diameter 12 mm / 0.47 of an inch

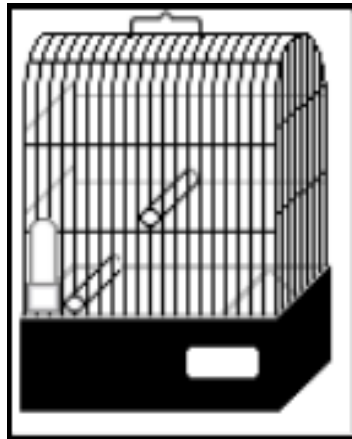

All colors are allowed except red.

Belgian Bossu

Standard

Points	Descriptions
Position 40	In the working position, the bird stretches the neck forward, shrugs the shoulders. In the shape of a 7. The head is invisible seen from behind. The back forms a vertical straight line with the tail. The bird pulls slightly on the legs.
General shape of the body 25	Long and wide chest, in the shape of a triangular corner, seen from the back or from the side. Full broad back, without being too hollow or too round. Shoulders: wide and high. Wings: long, adhered to the body.
Head and Neck 15	Small, oval head. Long and thin neck.
Plumage and Tail 10	Shiny plumage, as smooth as possible. Long, straight, narrow and well closed tail, in a straight line with the back. All colors are allowed except red.
Size 5	17 - 18 cm ; 6.7 – 7.08 inches. The size is measured from the tip of the beak to the end of the tail following the line of the back.
Legs and Thighs 5	Long legs, slightly bent, well feathered. The thighs stick to the body.

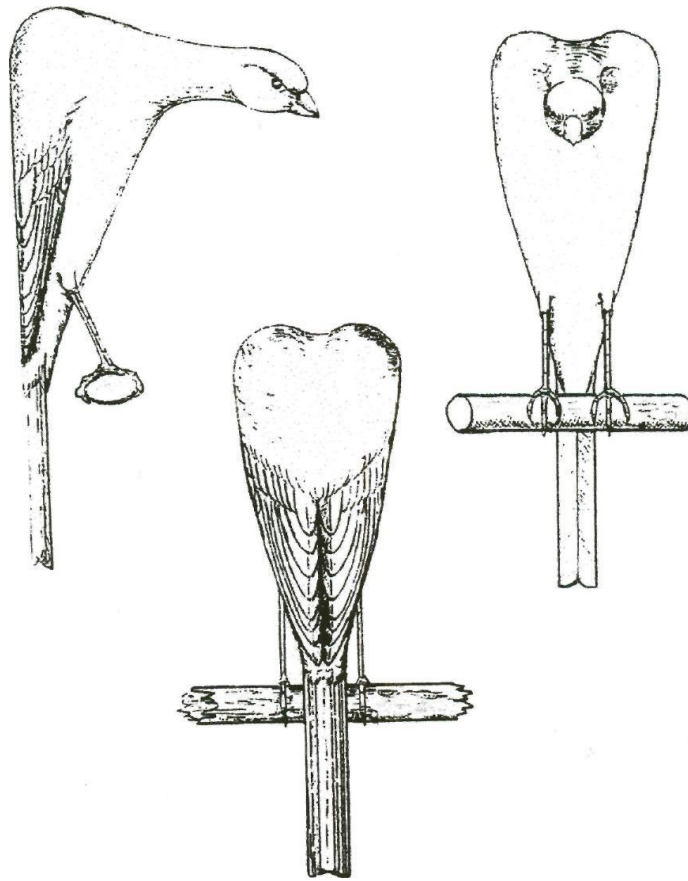

Technical drawing



Photograph

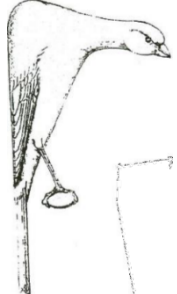

Judgement Sheet

 <p>CONFÉDÉRATION ORNITHOLOGIQUE MONDIALE</p>	<h2 style="margin: 0;">JUDGEMENT SHEET</h2>			 <p>CONFÉDÉRATION ORNITHOLOGIQUE MONDIALE</p>
	Exhibitor			
	Breeder Number	Ring (s)	Country	
Belgian Bossu				
Description:			E	Class
Cage number				
Position	40			
General shape of the body	25			
Head and Neck	15			
Plumage and Tail	10			
Size	5			
Legs and Thighs	5			
Total	100			
Observation :		Total		
		Harmony		
		Total for stamm		
Date :		Location :		
Judge :		Classification :		



Show cage :

Type C2 « Tunnel » with 2 round perches
(1 top perch in the middle of the cage + 1 bottom perch on the 4th bar from the left)

Diameter 12 mm / 0.47 of an inch

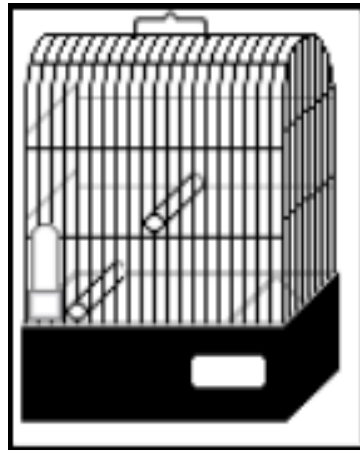

All colors are allowed except red.

Llarguet Español

Standard

Points	Descriptions
Position 20	Erect. Forming an angle of 60°.
Body 20	Elongated, slightly cylindrical, thin. Narrow, thin, without roundness.
Size 15	17 cm / 6,9 inches (minimum).
Legs 10	Long, slightly bent, thighs visible and covered with short feathers.
Head and Neck 10	Head: Small, oval. With conical and well proportioned beak. Neck: Medium, thin, it separates the head from the body.
Wings and Tail 10	Wings: Very long, adhered to the body, without crossing. Tail: Very long, narrow, ends slightly forked.
Plumage and Color 10	Short, smooth, compact, well adhered to the body. Uniform or variegated. Red factor allowed.
General condition 5	Healthy, clean. Comfortable int the cage.

Technical drawing

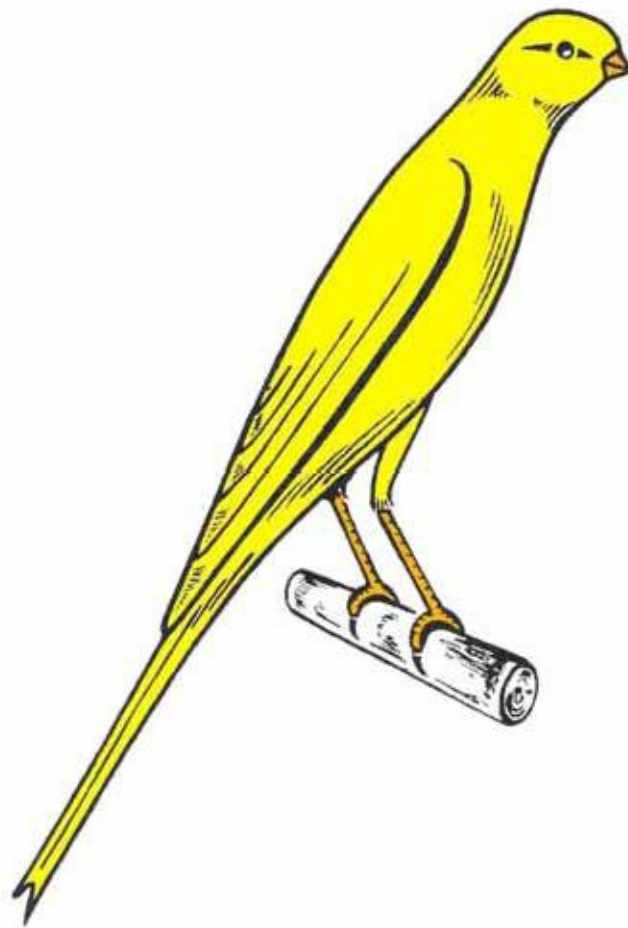

Photographie



Judgement Sheet



JUDGEMENT SHEET



	Exhibitor		
	Breeder Number	Ring (s)	Country

Llarguet Español

Description:		E	Class	
Cage number				
Position	60º	20		
Body		20		
Size (17 cm / 6.9 inches minimum)		15		
Legs		10		
Head and Neck		10		
Wings and Tail		10		
Plumage and Color		10		
General condition		5		
Total		100		
Observation :		Total		
		Harmony		
		Total for stamm		
Date :		Location :		
Judge :		Classification :		



Show cage :

Type C2 « Tunnel » with 2 round perches
(1 top perch in the middle of the cage + 1 bottom perch on the 4th bar from the left)

Diameter 12 mm / 0.47 of an inch

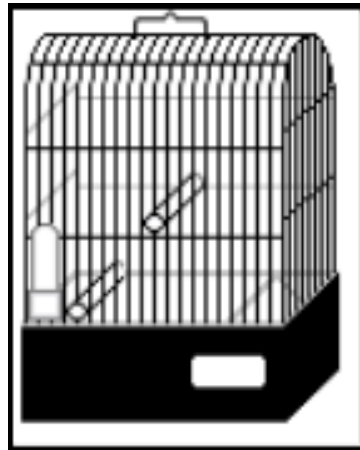

All colors are allowed.

Lancashire (Cuppy/Plainhead)

Standard

Points	Descriptions
Head and Crest 25	<p><u>Plainhead</u>: top of the skull broad and slightly flattened, with well-defined eyebrows that should not cover the eyes.</p> <p><u>Cuppy</u>: horseshoe shaped, more pronounced at the front part, leaves half of the eye free and well adhered to the nap of the neck.</p> <p>Melanin feathers are allowed in the crest but should not go beyond the area of the neck. Grizzled crests more appreciated than dark.</p>
Size 25	<p>21 cm / 8.25 inches.</p> <p>The goal will be to increase the size of the bird. Larger birds are preferred.</p>
Body, Plumage and Legs 20	<p>Full and long body.</p> <p>Point of greatest expansion between the abdomen and the chest.</p> <p>Broad and visible shoulders. Back broad, full and long.</p> <p>Plumage well furnished, thin and rather long. Long wings.</p> <p>Complete absence of "cock feathers".</p> <p>Legs long, strong, slightly bent and show part of the thighs.</p>
Position 15	<p>Erect and graceful posture.</p> <p>Tail long and wide, does not follow the line of the back so as to form a slight curve from the head to the tip of the tail.</p>
Nape and Neck 10	<p>Full and clearly visible neck. Retracted at the base "bottle neck".</p>
Condition 5	<p>Healthy, without defects. Perfect hygiene.</p> <p>Uniform color, white and yellow, intensive and non intensive.</p> <p>No melanin allowed except in the crest.</p>

Technical Drawing

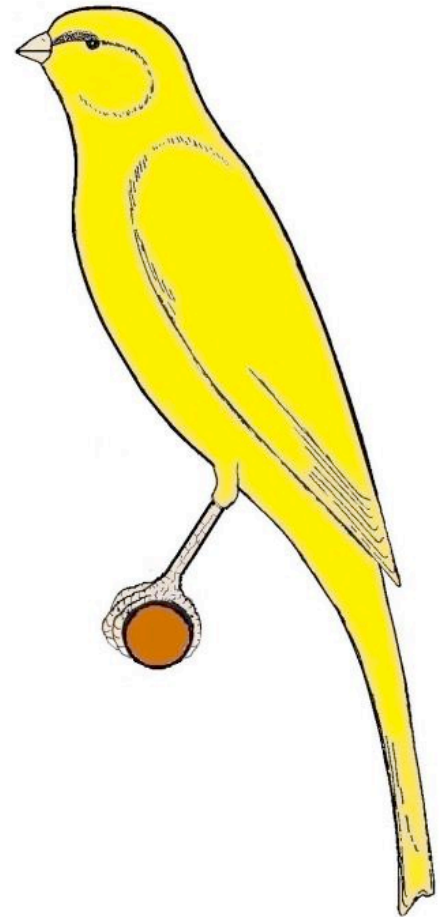
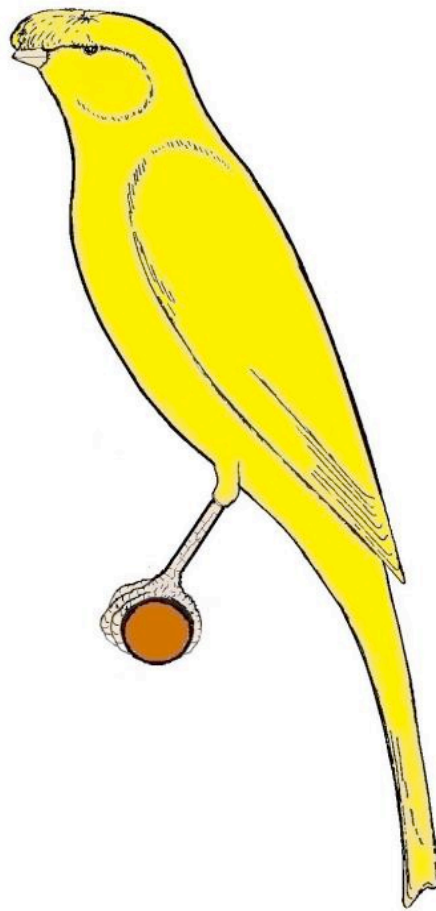

Photograph



Judgement Sheet



JUDGEMENT SHEET

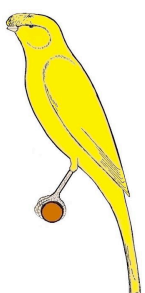

	Exhibitor		
	Breeder Number	Ring (s)	Country
Lancashire (Cuppy/Plainhead)			
Description :	Cuppy <input type="checkbox"/>	Plainhead <input type="checkbox"/>	E
Cage number			Class
Head and Crest	25		
Size	25		
Body, Plumage and Legs	20		
Position	15		
Nape and Neck	10		
Condition	5		
Total	100		
Observation :	Total		
	Harmony		
	Total for stamm		
Date :	Location :		
Judge :	Classification :		



Show cage :

Type C2 « Tunnel » with 2 round perches
(1 top perch in the middle of the cage + 1 bottom perch on the 4th bar from the left)

Diameter 14 mm / 0.55 of an inch

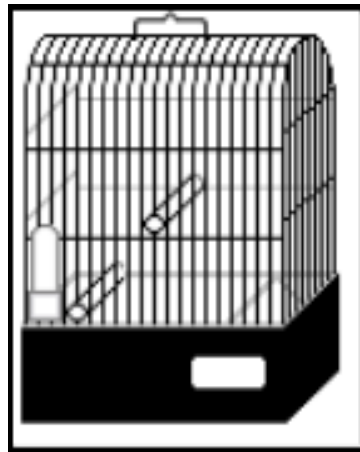

**Only yellow and white are allowed.
No melanin except in the crest.**

Münchener

Standard

Points	Descriptions
Position 20	Erect position. Forms with head, neck and back, a curved line. Half-moon-shaped in the upper part of the body.
Head and Neck 20	Small head. Long and thin neck.
Chest, Shoulders and Wings 20	Narrow chest and shoulders. Long wings and well adhered to the body.
Tail 10	Long and narrow tail that extends the line of the back, staying away from the perch.
Legs 10	Long and slightly bent legs.
Plumage and Color 10	Smooth plumage. All colors are allowed except red.
Size 5	15 to 16 cm / 6 to 6.3 inches, maximum.
Condition 5	Healthy, without deformities or defects.

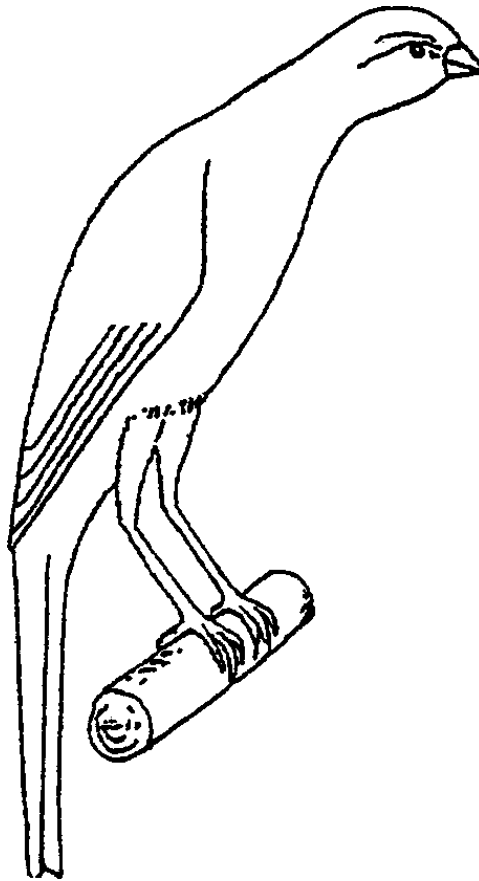

Technical drawing



Photograph

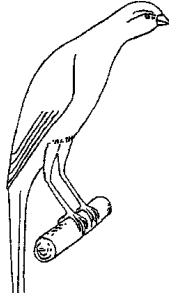

Judgement Sheet

	JUDGEMENT SHEET			
	Exhibitor			
	Breeder Number	Ring (s)	Country	
Münchener				
Description:			E	Class
Cage number				
Position	20			
Head and Neck	20			
Chest, Shoulders and Wings	20			
Tail	10			
Legs	10			
Plumage and Color	10			
Size (15 to 16cm / 6 to 6.3 inches)	5			
Condition	5			
Total	100			
Observation :		Total		
		Harmony		
		Total for stamm		
Date :		Location :		
Judge :		Classification :		

Show cage :

Type C2 « Tunnel » with 2 round perches
(1 top perch in the middle of the cage + 1 bottom perch on the 4th bar from the left)

Diameter 12 mm / 0.47 of an inch

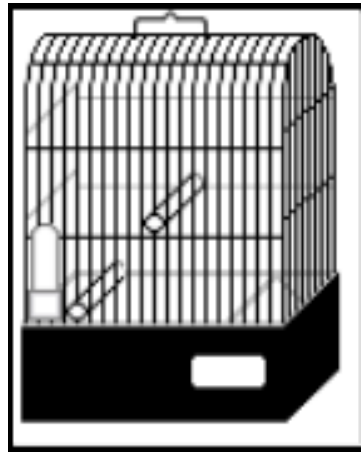

All colors are allowed except red.

Rheinländer

Standard

Points	Descriptions
Head and Crest 20	The crest should be horseshoe-shaped. Above the eyes, the crest extends forward. The crest should be symmetrical starting in the center of the head. The transition from the crest to nape of the neck should be flat and without a note of a crest. The "plainhead" with a fairly broad and slightly rounded head with recognizable eyebrows. Grey and dark crested are allowed.
Body 20	Slim and elegant. The chest and back are slightly rounded.
Position 20	Erect, the back is slightly rounded.
Size 15	No larger than 12 cm / 4.72 inches.
Plumage 10	Smooth and well adhered to the body.
Legs 5	Thin, delicate and slightly bent legs. The thighs are slightly visible.
Tail 5	Narrow and slightly forked.
Condition 5	Healthy. Clean. Uniform color, yellow, red and white. No melanin except in the crest.

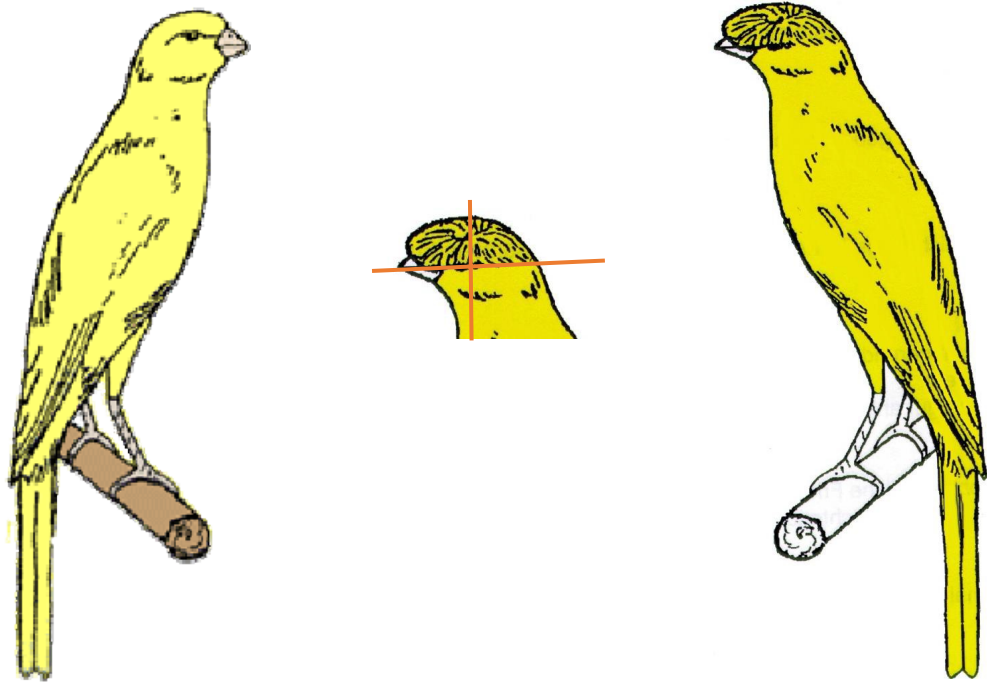

Technical drawing



Photograph

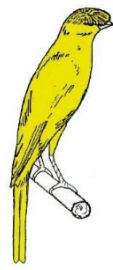

Judgement Sheet

	JUDGEMENT SHEET			
	Exhibitor			
	Breeder Number	Ring (s)	Country	
Rheinländer (Crest/Non-Crest)				
Description:	Crest <input type="checkbox"/>	Non-Crest <input type="checkbox"/>	E	Class
Cage number				
Head and Crest	20			
Body	20			
Position	20			
Size maximum 12 cm / 4.72 inches	15			
Plumage	10			
Legs	5			
Tail	5			
Condition	5			
Total	100			
Observation :	Total			
	Harmony			
	Total for stamm			
Date :	Location :			
Judge :	Classification :			



Show cage :

Type C2 « Tunnel » with 2 round perches
(1 top perch in the middle of the cage + 1 bottom perch on the 4th bar from the left)

Diameter 12 mm / 0.47 of an inch

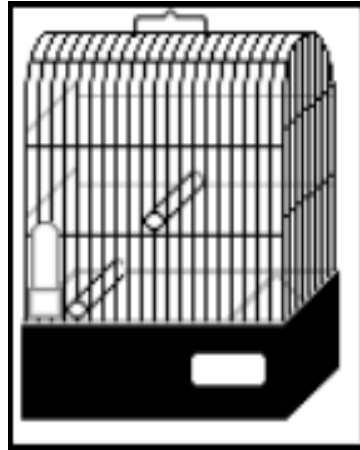

**Only yellow, red and white are allowed.
No melanin except in the crest.**

Salentino

Standard

Points	Descriptions
Position 25	The position is at right angles with the neck stretched and of medium length, the back perpendicular to the perch with the tail being the natural continuation.
Body Shape 20	The body should not form triangles wherever it is observed. The chest should be flattened without prominence. The back forms a straight line to the tail, the shoulders should be tight, not high and should not show any depression with the back. The tail will be slightly open, dovetail.
Size 20	The ideal size is 12.5 cm / 5 inches or less.
Crest - Head 15	The crest should be well centered, of oval shape, compact, perfectly adhered to the head, formed of feathers which do not cover the eyes. The head is oval and slightly flattened at the top.
Plumage and Color 10	Smooth, tight and well adhered plumage on each part of the body, the plumage should not be loose and must be without frilling. Ground color : artificial red coloring, should be bright and evenly distributed. Exceptions are subjects with white ground color, without coloring.
Legs 5	The legs should be slightly bent and parallel carried.
General Condition 5	Clean, healthy, attentive and lively.

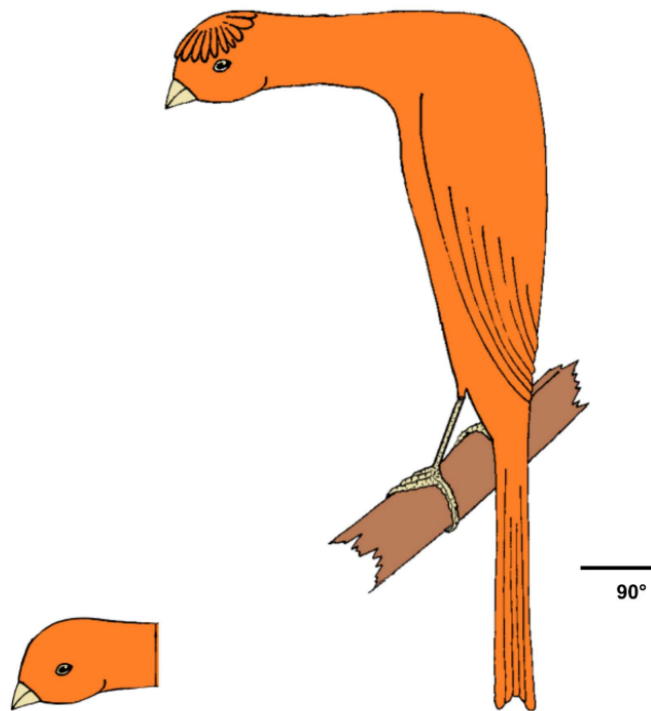

Technical drawing



Photograph

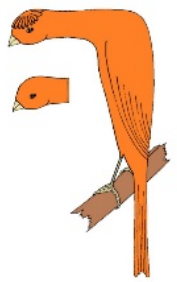

Judgement Sheet

	JUDGEMENT SHEET				
	Exhibitor				
	Breeder Number	Ring (s)	Country		
Salentino (Crest/Non-Crest)					
Description:	Crest <input type="checkbox"/>	Non-Crest <input type="checkbox"/>	E	Class	
Cage number					
Position	25				
Body Shape	20				
Size	20				
Crest - Head	15				
Plumage and Color	10				
Legs	5				
General condition	5				
Total	100				
Observation :	Total				
	Harmony				
	Total for stamm				
Date :	Location :				
Judge :	Classification :				

Show cage :

Type C2 « Tunnel » with 2 round perches
(1 top perch in the middle of the cage + 1 bottom perch on the 4th bar from the left)

Diameter 12 mm / 0.47 of an inch

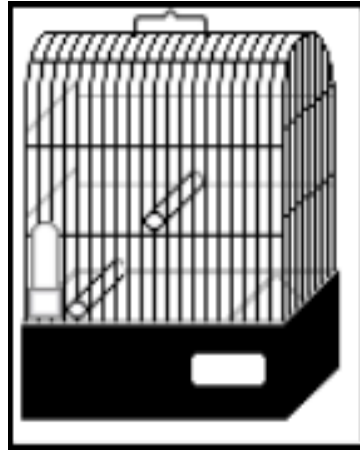

Red coloring mandatory except white ground color.

Yorkshire

Standard

Points	Descriptions
Position 25	Erect attitude, fearless carriage. Long legs, slightly bent, visible thighs.
Plumage 25	Compact, short and tight plumage. Wings proportionally long and symmetrically carried on each side of the back axis, touching a compact and tight tail.
Head 20	Full and round head. Full neck, carried evenly towards the top of the shoulders and back. Short beak. The eyes as close as possible to the center of the head.
Body 10	Shoulders proportionally broad, round and well carried and gradually emerging at the head. Full and deep chest, corresponding to the width and roundness of the shoulders and beginning at the base of the beak. All round and gradually decreasing (back and abdomen) towards the tail. The abdomen and the underside of the tail forming a straight line.
Size 10	Minimum 17 cm / 6.7 inches.
Condition and Color 10	Pure and well distributed color in case of artificial coloring. In good condition and healthy. Clean. All colors are allowed.

Technical drawing



Photograph



Judgement Sheet

	JUDGEMENT SHEET				
	Exhibitor				
	Breeder Number	Ring (s)	Country		
Yorkshire					
Description:			E	Class	
Cage number					
Position	25				
Plumage	25				
Head	20				
Body	10				
Size (Minimum 17 cm / 6.7 inches)	10				
Condition and Color	10				
Total	100				
Observation :		Total			
		Harmony			
		Total for stamm			
Date :		Location :			
Judge :		Classification :			

Show cage :

Type C2 « Tunnel » with 2 oval perches
(1 top perch in the middle of the cage + 1 bottom perch on the 4th bar from the left)

Diameter 14 x 9 mm / 0.55 x 0.35 of an inch

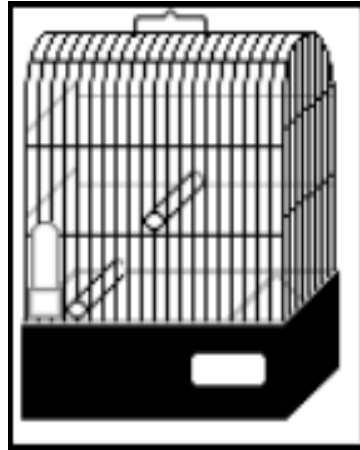

All colors are allowed.

**STANDARDS O.M.J. / C.O.M. OF
TYPE CANARIES
E2**



Frills - Section E2

HEAVY FRILLED (ABUNDANT CURL):

- Parisian Frill
- A.G.I.
- Crested Padovan
- Non-crested Padovan
- Mehringer
- Rogetto

In breeds in which "twisted or corkscrew nails" are a distinguishing factor in the quality of the breed - such as the AGI, Frisé Parisien, Rogetto and Mehringer breeds - these can be cut accordingly due to animal welfare regulations. This nail cut must be done just after the first curve of the nail and is not subject to any penalty in the judgment.

LIGHT FRILLED:

- North Frill
- South Frill
- Swiss Frill
- Melado Tinerfeño
- Gibber Italicus
- Giboso Español
- Giraldillo Sevillano
- Benacus
- Crested Fiorino
- Non-crested Fiorino

The Frilling

We distinguish three main frilling:

The mantle, the jabot and the fins.

a) The Mantle or the Back frill

- Straight median line which covers all or part of the back symmetrically.
- In the shape of a rose and/or "bouquet"



b) The Jabot: Chest frill in the shape of either

- Shell
- Basket
- Heart

c) Fins:

- Symmetrical and raised frills of the flanks.

To recognize the different frills apart from their respective frilling, there is also the position:

The position :

- Erected:
 - A.G.I. (60°)
 - Fiorino (55°)
 - Mehringer
 - North Frill (60°)
 - Padovan (65°)
 - Rogetto (60°)
 - Parisian Frill.
- In shape of 1:
 - Giboso Español
 - Giraldillo Sevillano
 - Mélado Tinerfeño
- In shape of 7:
 - Benacus
 - Gibber Italicus
 - South Frill
- In shape of half-moon:
 - Swiss Frill

Benacus

Standard

Points	Descriptions
Head and Neck 20	Crest: Complete crest, composed in accordance with the shape of the head, which starts from a central point, covering it entirely leaving the beak and the eyes uncovered. Non-crest: Smooth, hazelnut-shaped with no eye-brows. Neck: Long and smooth, stretched forward.
Position 15	In the shape of seven. Neck stretched horizontally at the level of the carpus in the working position, vertical body along with the tail and perpendicular to the perch.
Size 10	16 cm / 6.35 inches, well proportioned.
Jabot 10	Consisting of two curls that converge towards the center from both sides of the chest to completely cover the sternum.
Fins 10	Short, slightly bushy, symmetrical, facing upwards without covering the wings or reaching the mantle.
Legs and Thighs 10	Long, deplumed at the knees, slightly bent.
Mantle 5	With clear central demarcation, symmetrical, implanted between the back.
Plumage 5	Regular, shiny, not very voluminous. Smooth in the abdomen.
Wings 5	Long, uniform, well adhered to the body.
Tail 5	Length proportionate to the body, narrow and slightly forked at the end.
General Condition 5	In good health, active and clean. All colors are allowed.

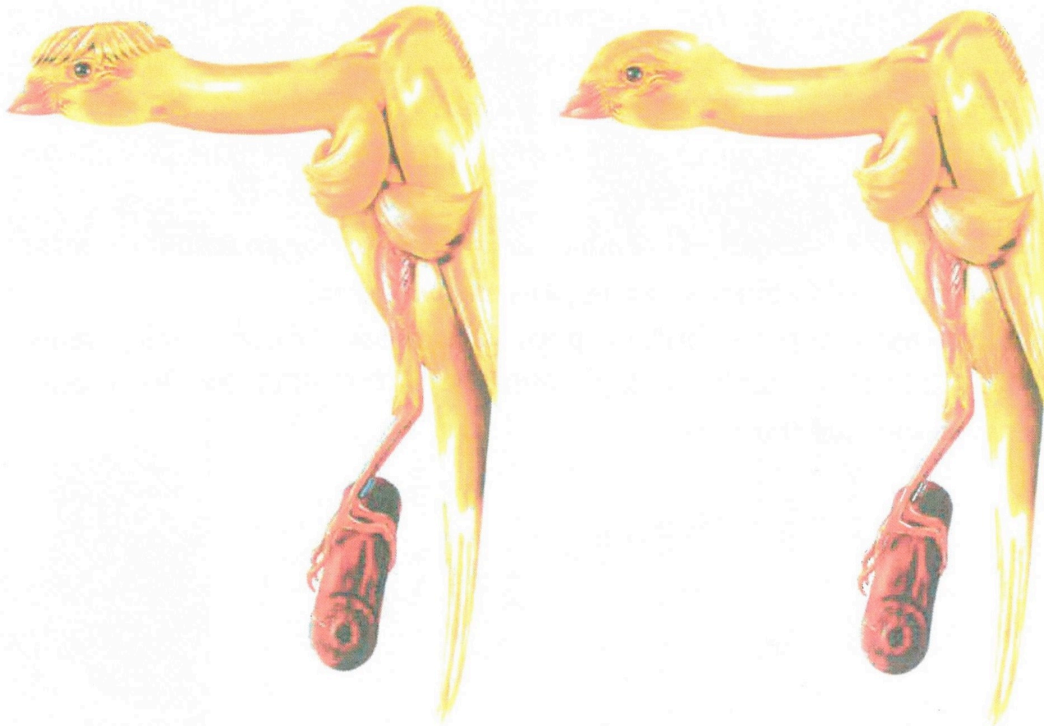

Technical drawing

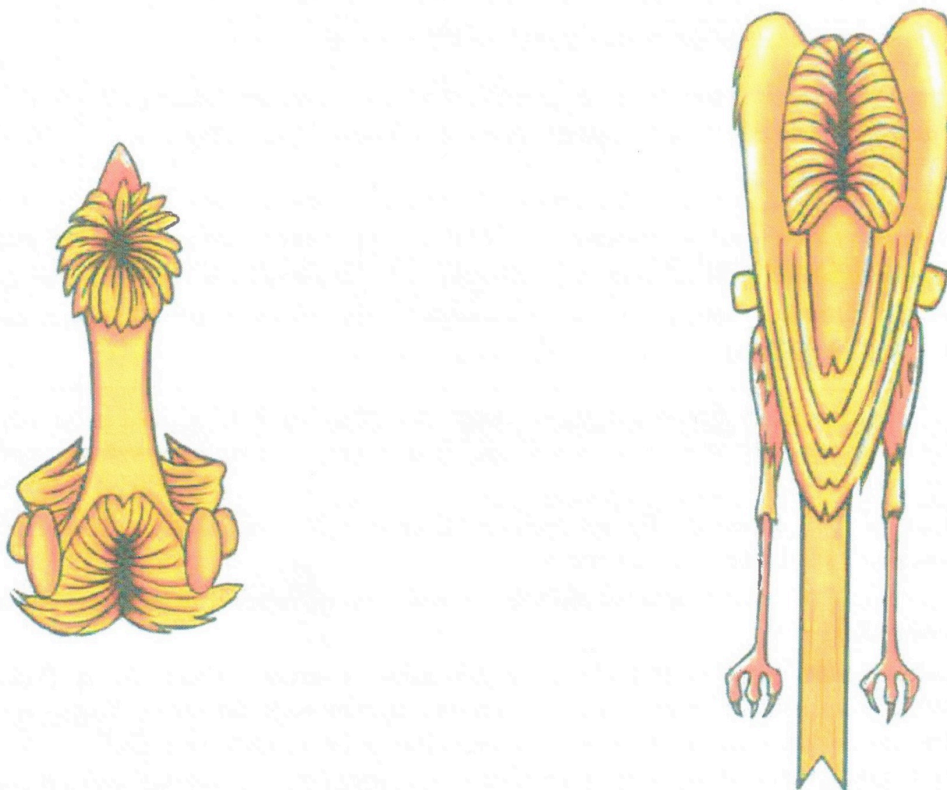

Photograph



Judgement Sheet

 <p>CONFÉDÉRATION ORNITHOLOGIQUE MONDIALE</p>	<h2 style="margin: 0;">JUDGEMENT SHEET</h2>				 <p>CONFÉDÉRATION ORNITHOLOGIQUE MONDIALE</p>
	Exhibitor				
	Breeder Number		Ring (s)		Country
Benacus					
Description:				E	Class
Cage number					
Head and Neck	20				
Position	15				
Size 16 cm. / 6,35 inches	10				
Jabot	10				
Fins	10				
Legs and Thighs	10				
Mantle	5				
Plumage	5				
Wings	5				
Tail	5				
Condition	5				
Total	100				
Observation :		Total			
		Harmony			
		Total for stamm			
Date :		Location :			
Judge :		Classification :			



Show cage :

Type C2 « Tunnel » with 2 round perches
(1 top perch in the middle of the cage + 1 bottom perch on the 4th bar from the left)

Diameter 12 mm / 0.47 of an inch

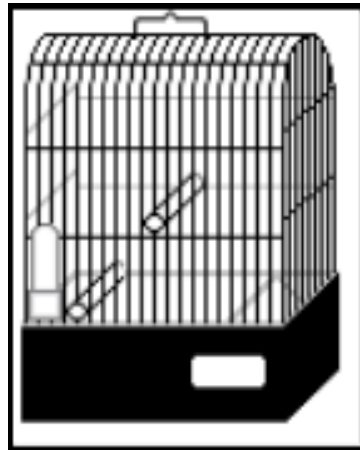

All colors are allowed.

Gibber Italicus

Standard

Points	Descriptions
Position 15	Permanently in the shape of 7. The head and neck go down lower than the shoulders. The head and neck form an angle of almost 90° with the body.
Head and Neck 15	<u>Head</u> : Serpentine, very small, smooth. <u>Neck</u> : As long and smooth as possible, slightly curved.
Legs and Thighs 10	Long legs and as perpendicular as possible with a slight inclination towards the back. Bare thighs on the front. The tarsus is perpendicular to the foot without forming an angle with the heel.
Mantle 10	Distributed symmetrically and well adhered to the wings. Not implanted too high.
Jabot 10	Small, short and symmetrical. In the shape of a comma. A small part of the sternum exposed at the throat.
Fins 10	Short but symmetrical, raised towards the shoulders without reaching them.
Size 10	Length 14 to 15 cm / 5.5 to 6 inches. Perfect proportions.
Wings 5	Regular and well adhered to the body.
Tail 5	Straight, narrow, homogeneous and complete.
Plumage 5	Rough and scanty, smooth abdomen. Only exposed in intensive and short plumage.
Condition 5	Active and healthy. All colors are allowed.

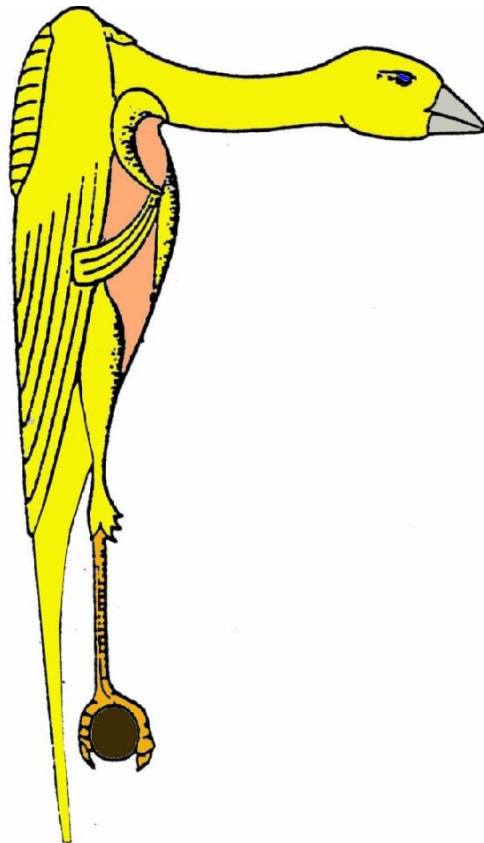

Technical drawing



Photograph



Judgement Sheet

	<h2 style="margin: 0;">JUDGEMENT SHEET</h2>			
	Exhibitor			
	Breeder Number	Ring (s)	Country	
Gibber Italicus				
Description:			E	Class
Cage number				
Position	15			
Head and Neck	15			
Legs and Thighs	10			
Mantle	10			
Jabot	10			
Fins	10			
Size (14 to 15 cm / 5.5 to 6 inches)	10			
Wings	5			
Tail	5			
Plumage	5			
Condition	5			
Total	100			
Observation :		Total		
		Harmony		
		Total for stamm		
Date :		Location :		
Judge :		Classification :		



Show cage :

Type C2 « Tunnel » with 2 round perches
(1 top perch in the middle of the cage + 1 bottom perch on the 4th bar from the left)

Diameter 12 mm / 0.47 of an inch

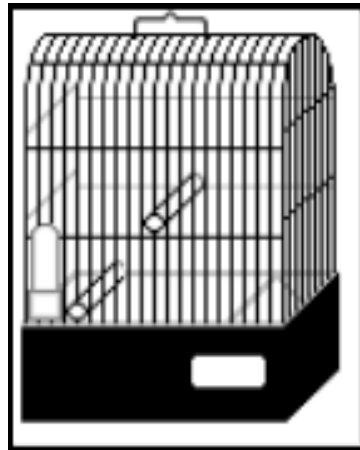

All colors are allowed.

Giboso Español

Standard

Points	Descriptions
Position and Type 20	In the shape of 1. In position, the neck and head should form an angle of 45° to 60° with the trunk. Type : shows clearly the frilled and smooth parts.
Head and Neck 20	Small, serpentine and smooth head. Conical and proportionate beak. Neck: Very long, smooth and slender downwards.
Size 10	Minimum 18 cm / 7 inches.
Legs and Thighs 10	Long and rigid legs. Thighs un-feathered in front and slightly bent back.
Jabot and Abdomen 10	Well proportioned with the frilling inwards on each side towards the center, so as to show the sternum completely bare. Smooth abdomen.
Wings and Mantle 10	Wings long in proportion and well adhered to the body without crossing. The tips of the wings slightly detached from the body. In proportion. Shoulders carried high with symmetrically distributed frills on each side of a midline that forms a mantle that covers well the back.
Fins 5	Slight frilling that start symmetrically on each side of the body to form two small flanks.
Tail 5	In proportion to the body, narrow and directed slightly towards the perch to touch it gently.
Plumage 5	Plumage well closed on the smooth parts and sparse on the frilled parts. All colors are allowed.
Condition 5	Healthy and clean. Used to the show cage.

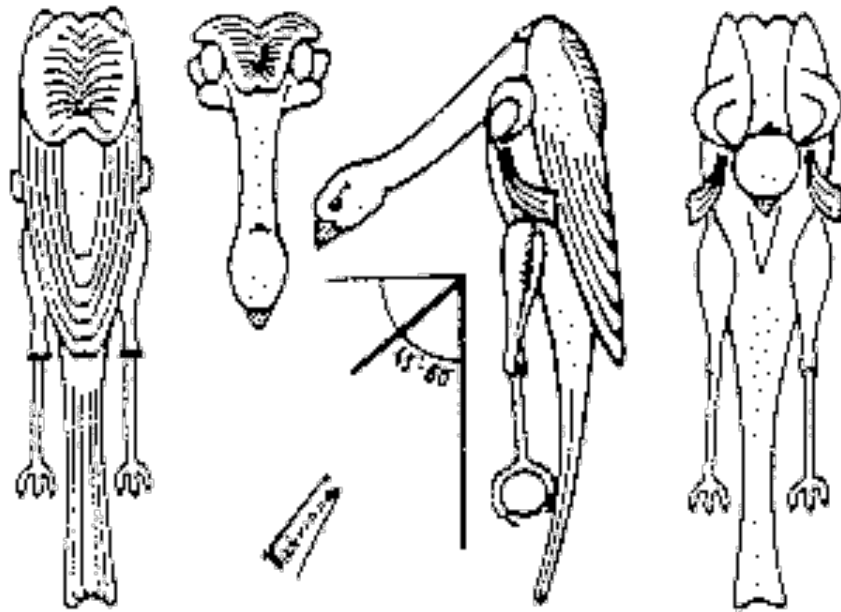

Technical Drawing



Photograph



Judgement Sheet

 <p>C.O.M. CONFEDERATION ORNITHOLOGIQUE MONDIALE</p>	<h2 style="margin: 0;">JUDGEMENT SHEET</h2>			 <p>O.M.J. CONFEDERATION ORNITHOLOGIQUE MONDIALE</p>
	Exhibitor			
	Breeder Number	Ring (s)	Country	
Giboso Español				
Description:			E	Class
Cage number				
Position and Type	20			
Head and Neck	20			
Size	10			
Legs and Thighs	10			
Jabot and Abdomen	10			
Wings and Mantle	10			
Fins	5			
Tail	5			
Plumage	5			
Condition	5			
Total	100			
Observation :		Total		
		Harmony		
		Total for stamm		
Date :		Location :		
Judge :		Classification :		



Show cage :

Type C2 « Tunnel » with 2 round perches
(1 top perch in the middle of the cage + 1 bottom perch on the 4th bar from the left)

Diameter 14 mm / 0.55 of an inch.

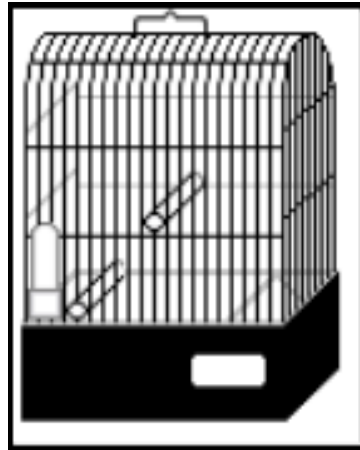

All colors are allowed.



Giraldillo Sevillano

Standard

Points	Descriptions
Position 20	In the shape of one (1), the trunk at the vertical to the perch, neck inclined with an angle of minimum 45 ° and the tail that touches the perch.
Size 15	Max. 15 cm. / 6 inches, preference will be given to the smallest. The size is calculated as follows: A) from the tip of the beak to the center of the shoulders. B) from the center of the shoulders to the base of the tail. C) from the base of the tail to the tip of the tail. B and C should not be more than 9 cm / 3.5 inches.
Crest 15	Crest oval as the head, bushy, with feathers as long as possible, with a central point and adhered to the nape of the neck.
Head and Neck 15	<u>Head</u> : small, oval, slightly raised in relation to the neck line and covered with smooth feathers. Proportionate beak. <u>Neck</u> : Very long, thin, sloping and covered with smooth feathers. Without frills.
Legs 10	Very long, rigid. Thighs un-feathered in front and visible at the junction with the body.
Chest 5	Long, narrow with visible sternum, looking like a comma . A feathered sternum is to be penalized to the maximum.
Back 5	Long in form, narrow, shoulders carried high. Short, symmetrical, well proportioned mantle distributed on each side of the midline of the back. Wings adhered to the body without crossing each other, the tips of the wings slightly detaching from the body.
Fins 5	Symmetrical in volume and height, small and adherent to the body. If it misses a fin, strong penalization.
Tail 5	Narrow, closed and grazing the perch, ending in an inverted "M" shape.
General Condition and Plumage 5	Plumage : fine, well adhered to the body. Healthy and clean. Complete plumage. Only the crested is allowed in judgement.

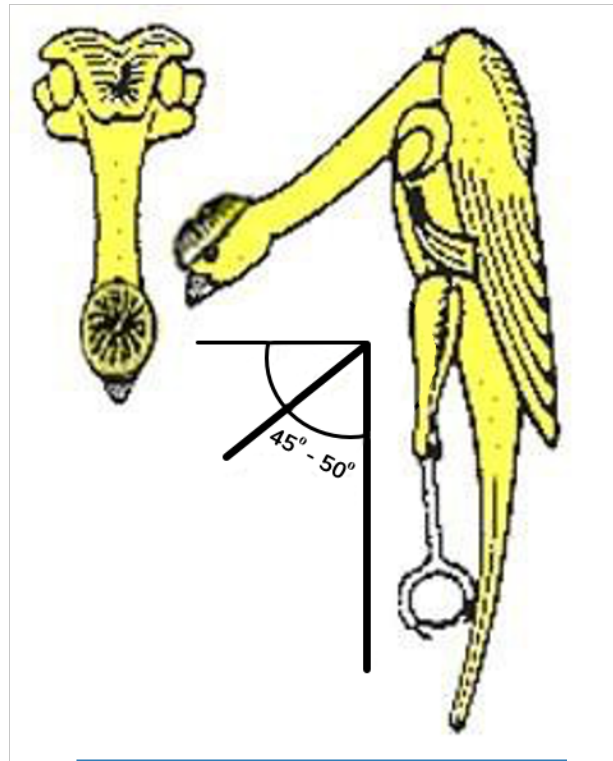

Technical drawing

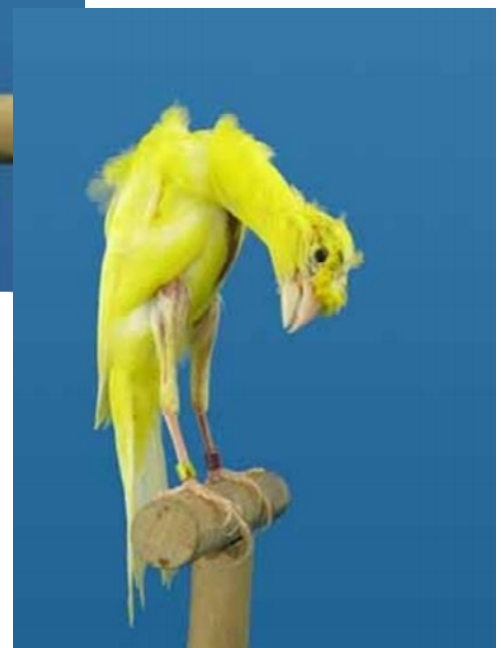
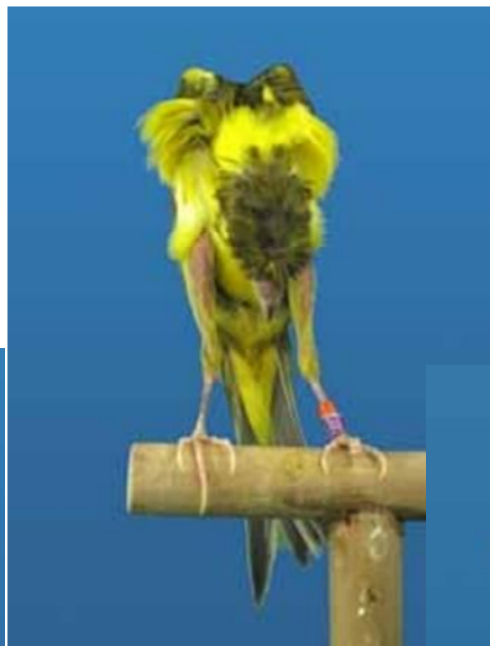

Photograph



Judgement Sheet

	<h2 style="margin: 0;">JUDGEMENT SHEET</h2>				
	Exhibitor				
	Breeder Number		Ring (s)		Country
Giraldillo Sevillano					
Description:				E	Class
Cage number					
Position	20				
Size	15				
Crest	15				
Head and Neck	15				
Legs	10				
Chest	5				
Back	5				
Fins	5				
Tail	5				
General Condition and Plumage	5				
Total		100			
Observation :		Total			
		Harmony			
		Total for stamm			
Date :		Location :			
Judge :		Classification :			

Show cage :

Type C2 « Tunnel » with 2 round perches
(1 top perch in the middle of the cage + 1 bottom perch on the 4th bar from the left)

Diameter 12 mm / 0.47 of an inch

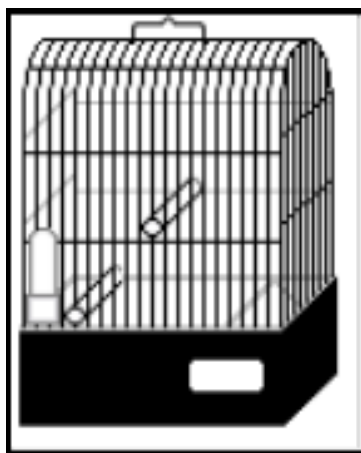

Only the crested is allowed.
All colors are allowed.

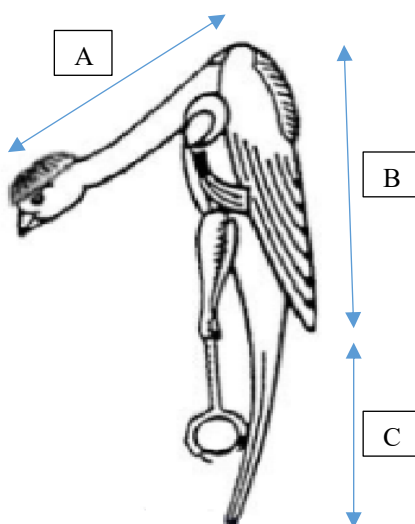

South Frill

Standard

Points	Descriptions
Position 15	In the shape of number 7.
Legs 10	Long, straight and well feathered.
Plumage 10	As smooth as possible, without frills in the expected areas: head, neck and abdomen.
Size 10	17 cm / 6.7 inches.
Mantle 10	Symmetrical, well developed. Clear and straight midline. Carried high.
Jabot 10	Symmetrical. Basket shape.
Fins 10	Upward and symmetrical. High implantation just in front of the thighs.
Head and Neck 10	<u>Head</u> : fine, serpentine and smooth. <u>Neck</u> : long and smooth; leaning forward.
Tail 5	Narrow and closed.
Wings 5	Joined wings, not crossed.
Condition 5	Good presentation. Optimal health. All colors are allowed.

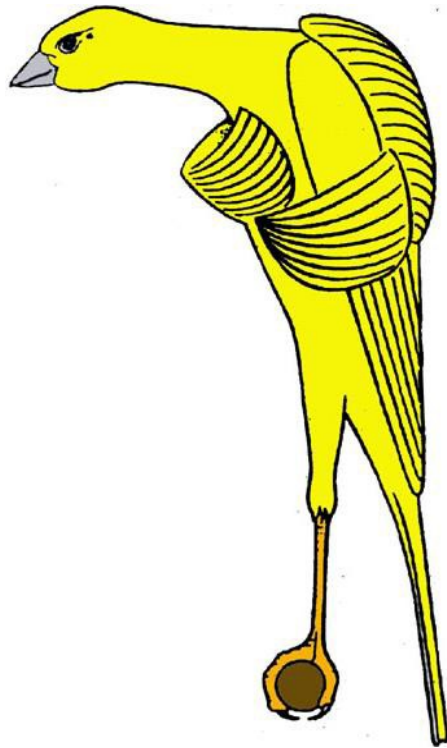

Technical drawing



Photograph

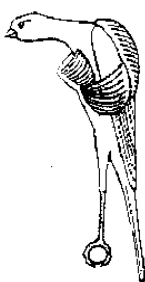

Judgement Sheet

	<h2 style="margin: 0;">JUDGEMENT SHEET</h2>			
	Exhibitor			
	Breeder Number	Ring (s)	Country	
<h3 style="margin: 0;">South Frill</h3>				
Description:			E	Class
Cage number				
Position	15			
Legs	10			
Plumage	10			
Size	10			
Mantle	10			
Jabot	10			
Fins	10			
Head and Neck	10			
Tail	5			
Wings	5			
Condition	5			
Total		100		
Observation :		Total		
		Harmony		
		Total for stamm		
Date :		Location :		
Judge :		Classification :		



Show cage :

Type C2 « Tunnel » with 2 round perches
(1 top perch in the middle of the cage + 1 bottom perch on the 4th bar from the left)

Diameter 12 mm / 0.47 of an inch

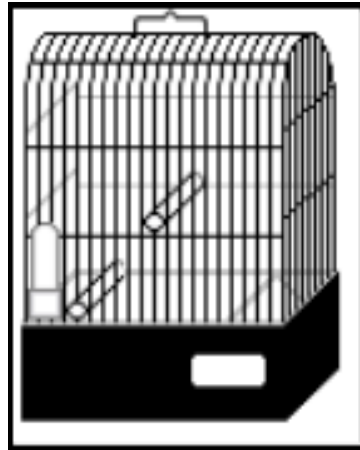

All colors are allowed.

Swiss Frill

Standard

Points	Descriptions
Posture and form 15	Elliptical shape. Half moon.
Legs 15	Long and slightly bent. Thighs feathered. Too rigid legs give the bird a too angular position. Bird taking the bar attitude typical of the South Frill (minimum 4 points of penalty).
Size 10	17 to 18 cm / 6.7 to 7 inches.
Head and Neck 10	Head : small and oval. Neck : long and fine. Without frilling.
Plumage 10	Head, neck and abdomen without frilling.
Mantle 10	Symmetrical and covering about 2/3 of the back.
Jabot 10	Symmetrical. Basket shape.
Fins 10	Symmetrical and well developed. Well established and raised.
Tail and Wings 5	Long tail. Narrow passing slightly under the perch. Long wings that do not cross.
Condition 5	Healthy. Without deformations or defects. All colors are allowed, except red.



Technical drawing



Photograph

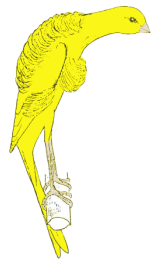

Judgement Sheet

 JUDGEMENT SHEET 			
	Exhibitor 		
	Breeder number	Ring (s)	Country
Swiss Frill			
Description :		E	Class
Cage number			
Posture and Form	15		
Legs	15		
Size	10		
Head and Neck	10		
Plumage	10		
Mantle	10		
Jabot	10		
Fins	10		
Tail and Wings	5		
Condition	5		
Total	100		
Observation :		Total	
		Harmony	
		Total for stamm	
Date :		Location :	
Judge :		Classification :	

Show cage :

Type C2 « Tunnel » with 2 round perches
(1 top perch in the middle of the cage + 1 bottom perch on the 4th bar from the left)

Diameter 12 mm / 0.47 of an inch

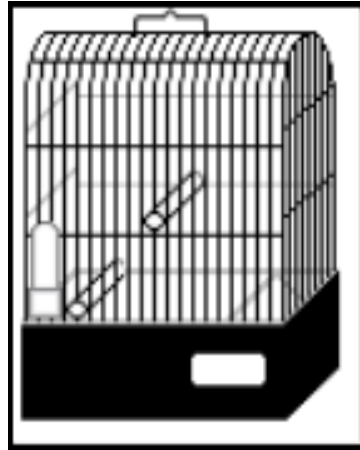

All colors are allowed except red.

Mélado Tinerfeño

Standard

Points	Descriptions
Position 20	Erected in the shape of number 1, seen from behind the head is not visible. In the working position, the shoulders are raised as high as possible. Head and neck projected forward. The legs are vertical and straight. Tail perpendicular to the perch. Shape: large, voluminous, perfectly noticeable in the areas of smooth and curly feathers.
Neck and Head 20	Neck: as long as possible and thick (from beak to shoulder more than 5 cm / 2 inches), covered with smooth feathers. Cylindrical. Always projected forward and downward forming an angle of 45° or less to the body. Head: Proportionate, covered with smooth feathers. Conical and proportionate beak.
Jabot (Chest) 20	Wide, with short frills that arise symmetrically from each side of the chest to the center, so as to allow to see the sternum and abdomen covered with smooth and short feathers. Smooth abdomen.
Fins (Flanks) 10	Curly feathers which are born on both sides of the body and form two large fins, tight, symmetrical without adherence to the wings.
Size 10	Minimum 18 cm / 7 inches.
Mantle (shoulders) and Wings 10	Broad, with high shoulders, with feathers that start symmetrically from the midline of the back and fall abundantly on both sides of the back forming a very voluminous mantle. Long and well adhered to the body, without crossing.
Legs and Tail 5	Long, stiff, with feathered thighs. Long and tight tail. Perpendicular to the perch.
General condition 5	Healthy and clean. Accustomed to the cage. All colors are allowed.

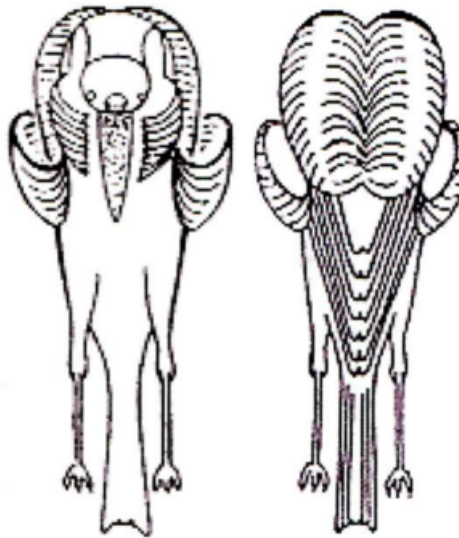

Technical drawing



Photograph



Judgement Sheet

	JUDGEMENT SHEET			
	Exhibitor			
	Breeder Number	Ring (s)	Country	
Mélado Tinerfeño				
Description :			E	Class
Cage number				
Position	20			
Neck and Head	20			
Jabot (Chest)	20			
Fins (Flanks)	10			
Size minimum 18 cm / 7 inches	10			
Mantle (Shoulders) and Wings	10			
Legs and Tail	5			
General Condition	5			
Total	100			
Observation :		Total		
		Harmony		
		Total for stamm		
Date :		Location :		
Judge :		Classification :		

Show cage :

Type C2 « Tunnel » with 2 round perches
(1 top perch in the middle of the cage + 1 bottom perch on the 4th bar from the left)

Diameter 12 mm / 0.47 of an inch

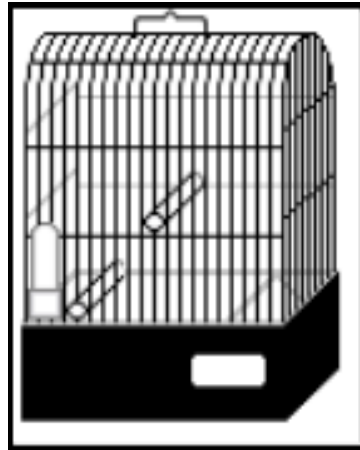

All colors are allowed.

Fiorino

Standard

Points	Descriptions
Size and Shape 15	Voluminous. Good shape, well filled. 13 cm / 5.1 inches – with perfect proportions.
Head and Neck 15	<u>Crest</u> : round and regular, symmetrical. Central point of the crest well in the center of the skull. Visible eye. <u>Non-crest</u> : large, smooth and round head with visible eyebrows. <u>Neck</u> : smooth, well exposed with or without small bare spot.
Position 10	Erected, body and tail forms an angle of 55° with the horizontal.
Plumage 10	Silky, voluminous. Smooth on the abdomen.
Mantle and Shoulders 10	<u>Mantle</u> : symmetrically distributed on the whole back. <u>Shoulders</u> : well developed.
Fins 10	Voluminous, symmetrical, raised just above the edge of the shoulders. Good implantation like the other lightly frill feathers.
Jabot 10	Symmetrical, voluminous. Closed shell shape.
Wings 5	Regular, complete and well adhered to the body.
Legs and Thighs 5	Long, well feathered, strong toes and nails.
Tail 5	Short and narrow.
Condition 5	Clean, active and healthy. All colors are allowed.

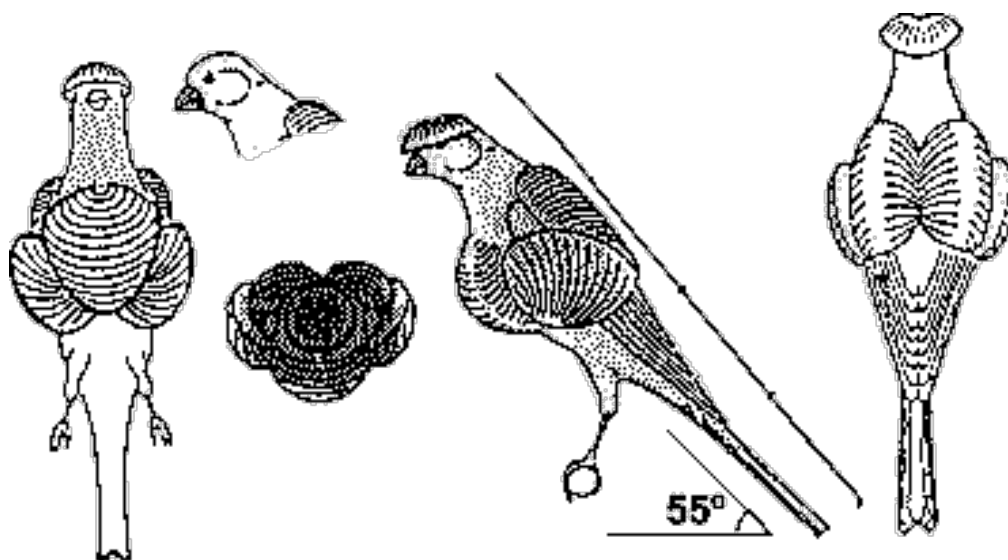

Technical drawing



Photograph



Judgement Sheet

	JUDGEMENT SHEET				
	Exhibitor				
	Breeder Number	Ring (s)	Country		
Fiorino (Crest/Non Crest)					
Description :		Crest <input type="checkbox"/>	Non Crest <input type="checkbox"/>	E	Class
Cage number					
Size and Shape	15				
Head and Neck	15				
Position	10				
Plumage	10				
Mantle and Shoulders	10				
Fins	10				
Jabot	10				
Wings	5				
Legs and Thighs	5				
Tail	5				
Condition	5				
Total	100				
Observation :		Total			
		Harmony			
		Total for stamm			
Date :		Location :			
Judge :		Classification :			

Show cage :

Type C3 « Border » with 2 round perches spaced 10.2 cm / 4 inches apart

Diameter 12 mm / 0.47 of an inch

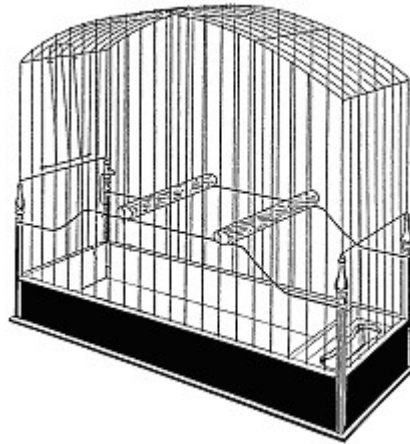

All colors are allowed.

AGI (Arricciato Gigante Italiano)

Standard

Points	Descriptions
Head, Neck, Collar 15	<u>Head</u> : round and voluminous with a conical beak, broad at the base. Complete or partial curl of the head (Cap), the eye is visible. <u>Neck</u> : smooth feathers with a frill in the shape of a collar all around. <u>Collar</u> : straight and turned up, shaped like a gutter.
Fins 15	Voluminous, long. Broad above the thighs, rising symmetrically on both sides to the curve of the wings.
Size 10	Minimum length 21 cm / 8.2 inches. In harmony with the whole.
Plumage 10	Supple and fine, very voluminous. All colors are allowed.
Mantle and Bouquet 10	<u>Mantle</u> : wide, long, very extensive feathers forming a rose-like curl from the central area on the back. <u>Bouquet</u> : small, but the arrangement on the rump is abundant.
Jabot and Abdomen 10	<u>Jabot</u> : voluminous. On both sides, the feathers converge upwards, forming a "fan" in the area near the collar, without causing any opening. <u>Abdomen</u> : rich in frills. The feathers are oriented upwards and unite with the jabot without forming empty spaces.
Tail 10	Long and wide, with rooster feathers. The end is closed.
Position 5	Proud, forming an angle of about 60° by relative to the perch. The tail, in the continuation of the back is slightly drooping.
Wings 5	Regular and powerful, adhered to the body. A slight crossing of the ends is allowed.
Legs and Feet 5	<u>Legs</u> : Robust and strong. <u>Feet</u> : strong, ensuring a good grip on the perch. Twisted or tended to twist nails.
General condition 5	The bird is clean and presents itself in good condition. Vigilant attitude, used to the exhibition cage.

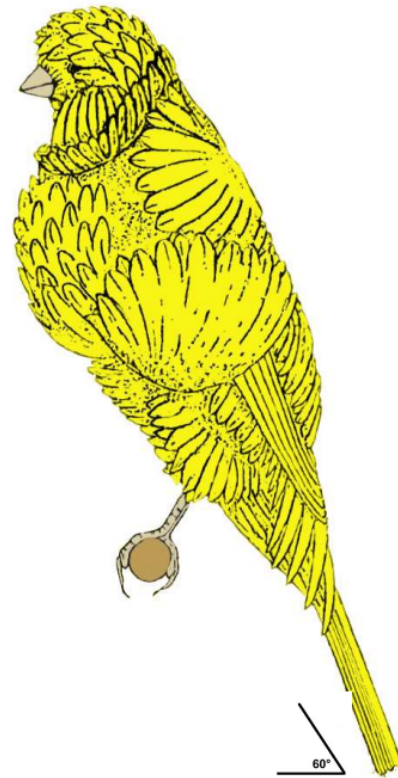

Technical drawing



Photograph



Judgement Sheet

	JUDGEMENT SHEET				
	Exhibitor				
	Breeder Number		Ring (s)		Country
AGI					
Description:				E	Class
Cage number					
Head, Neck, Collar	15				
Fins	15				
Size	10				
Plumage	10				
Mantle and Bouquet	10				
Jabot and Abdomen	10				
Tail	10				
Position	5				
Wings	5				
Legs and Feet	5				
General condition	5				
Total		100			
Observation :		Total			
		Harmony			
		Total for stamm			
Date :		Location :			
Judge :		Classification :			



Show cage :

Type C1 « Parisian Frill » with 2 round perches spaced 12 to 13 cm / 4.72 to 5.11 inches apart.

Diameter 14 mm / 0.55 of an inch

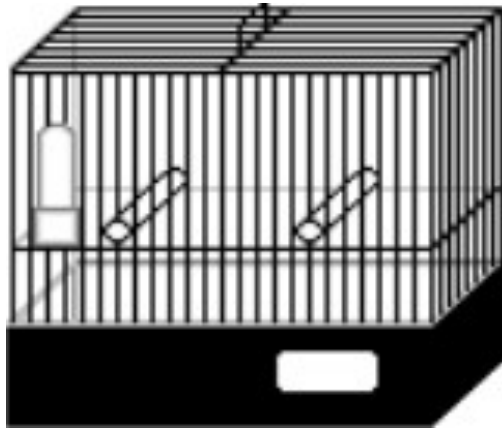

All colors are allowed.

North Frill

Standard

Points	Descriptions
Mantle and Shoulders 15	Symmetrical mantle, well developed, starting from the midline towards the shoulders. Well developed (2/3 of the back).
Jabot 15	In the shape of a closed shell.
Fins 15	Symmetrically implanted; from the fins to the shoulders. Implantation not too high or too low, in front of the legs.
Position 15	Erect position (60°). Legs quite long, slightly bent.
Size 10	17 to 18 cm / 6.7 to 7 inches.
Head and Neck 10	Small round head, not too heavy beak. Thin neck. Head, neck and nape are free of curls. Neck of proportionate length.
Abdomen 10	Absence of frilling.
Tail 5	Long and narrow tail.
General condition 5	In good health. Clean, without deformations or defects.

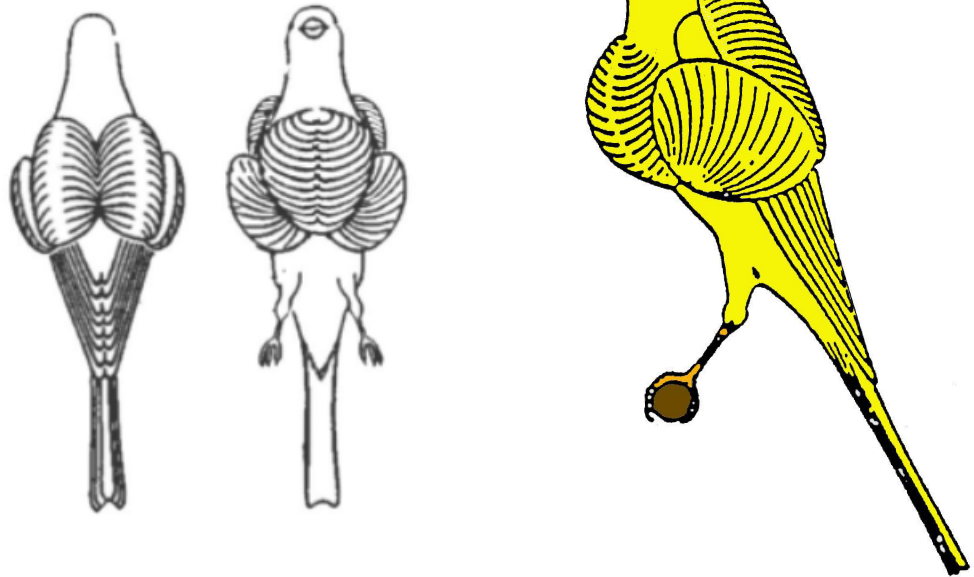

Technical drawing



Photograph

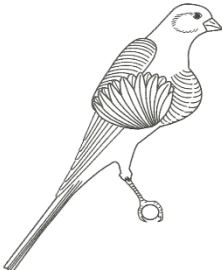

Judgement Sheet

	JUDGEMENT SHEET			
	Exhibitor			
	Breeder Number	Ring (s)	Country	
North Frill				
Description:			E	Class
Cage number				
Mantle and Shoulders	15			
Jabot	15			
Fins	15			
Position	15			
Size	10			
Head and Neck	10			
Abdomen	10			
Tail	5			
General condition	5			
Total	100			
Observation :		Total		
		Harmony		
		Total for stamm		
Date :		Location :		
Judge :		Classification :		

Show cage :

Type C1 « Parisian Frill » with 2 round perches spaced 12 to 13 cm / 4.72 to 5.1 inches apart

Diameter 12 mm / 0.47 of an inch

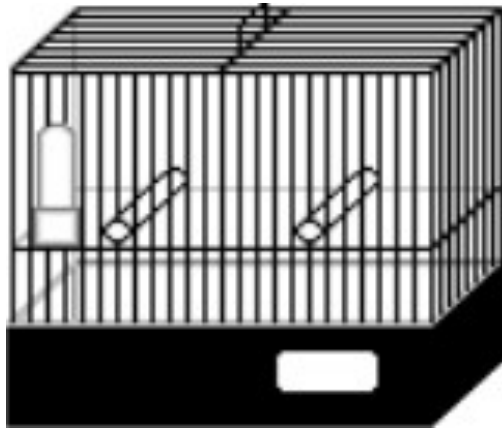

All colors are allowed.

Parisian Frill

Standard

Points	Descriptions
Head - Collar Sideburns 15	<u>Beak</u> : strong. <u>Head</u> : strong with a helmet of feathers folded down to the left or to the right on each side. The head is inserted into the shoulders by a corolla of straightened feathers forming a collar. The cheeks are provided with sideburns.
Mantle Shoulders Bouquet 15	<u>Mantle</u> : long, covering 2/3 of the length of the wings, broad, falling symmetrically on each side of the median line of the back. <u>Bouquet</u> : abundant, implanted in the bottom of the mantle and between the wings, directed on the left or on the right.
Jabot 15	Voluminous, closed in the shape of a shell, symmetrical with no hole underneath.
Fins 15	Strong, wide, symmetrical, well established in the flanks. Oriented as much as possible towards the top of the back. Totally distinct from the jabot.
Rooster feathers Olive - Breeches 10	<u>Rooster feathers</u> : abundant, falling on each side of the tail. <u>Olive</u> : presence of a bouquet of tight feathers going from the femur to the birth of the tail. <u>Breeches</u> : abundant, leaving no holes under the abdomen.
Legs, Tail, Wings 10	<u>Legs and Feet</u> : long, strong with thick nails, the thumbnail at least twisted into a corkscrew. <u>Tail</u> : long and thick, its tip is square. The whole practically follows the line of the back. <u>Wings</u> : long, without exaggerated crossing.
Size, Shape, Position 10	<u>Size</u> : the largest possible and with minimum 19 cm / 7.5 inches. <u>Shape</u> : harmonious – Massive appearance. <u>Position</u> : semi-erect, proud, majestic.
Plumage and Condition 10	<u>Plumage</u> : abundant, voluminous and silky. <u>Condition</u> : presented in good health and cleanliness. All colors are allowed.



Technical drawing



Photograph



Judgement Sheet

	<h2 style="margin: 0;">JUDGEMENT SHEET</h2>				
	Exhibitor				
	Breeder Number		Ring (s)		Country
Parisian Frill					
Dénomination:				E	Class
Cage number					
Head – Collar Sideburns	15				
Mantle - Shoulders, Bouquet	15				
Jabot	15				
Fins	15				
Rooster feathers, Olive - Breeches	10				
Legs, Tail, Wings	10				
Size, Shape, Position	10				
Plumage and Condition	10				
Total	100				
Observation :		Total			
		Harmony			
		Total for stamm			
Date :		Location :			
Judge :		Classification :			

Show cage :

Type C1 « Parisian Frill » with 2 round perches spaced 12 to 13 cm / 4.72 to 5.1 inches apart

Diameter 14 mm / 0.55 of an inch

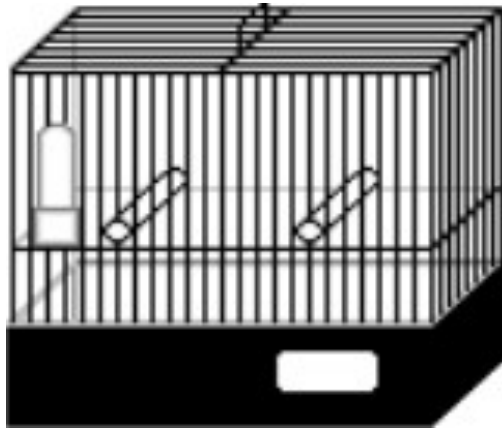

All colors are allowed.

Mehringer

Standard

Points	Descriptions
Size 20	13 cm / 5.1 inches.
Mantle and Bouquet 15	<u>Mantle</u> : voluminous, falling symmetrically on each side of a median line. <u>Bouquet</u> : The bouquet is an additional plumage, implanted in the bottom of the mantle and between the wings, directed on the left or on the right side.
Jabot and Abdomen 15	The plumage on both sides of the chest runs and touches in the middle of the chest. The abdomen is also frilled.
Fins 15	The flanks above the thighs are voluminous and on both sides symmetrically rising.
Head, Collar, Sideburns 10	The head of the Mehringer is rather broad and well frilled, it must be in harmony with the proportions of the body. The head is inserted into the shoulders by a corolla of straightened feathers forming a collar. The cheeks are provided with sideburns.
Legs and Feet 5	Short, with frilled legs. Nails twisted or tended to be twisted.
Tail 5	The tail should be wide and tight. Rooster feathers are present on both sides of the tail.
Position 5	The maintenance is erected. The head, back and tail should show a straight line.
Plumage 5	Voluminous and silky.
Condition 5	Presented in good conditions of health and cleanliness. All colors are allowed.



Technical drawing



Photograph



Judgement Sheet

	JUDGEMENT SHEET			
	Exhibitor			
	Breeder Number	Ring (s)	Country	
Mehringer				
Description:			E	Class
Cage number				
Size	13 cm / 5.1 inches	20		
Mantle and Bouquet		15		
Jabot and Abdomen		15		
Fins		15		
Head, Collar, Sideburns		10		
Legs and Feet		5		
Tail		5		
Position		5		
Plumage		5		
Condition		5		
Total		100		
Observation :		Total		
		Harmony		
		Total for stamm		
Date :		Location :		
Judge :		Classification :		

Show cage :

Type C1 « Parisian Frill » with 2 round perches spaced 12 to 13 cm / 4.72 to 5.1 inches apart

Diameter 12 mm / 0.47 of an inch

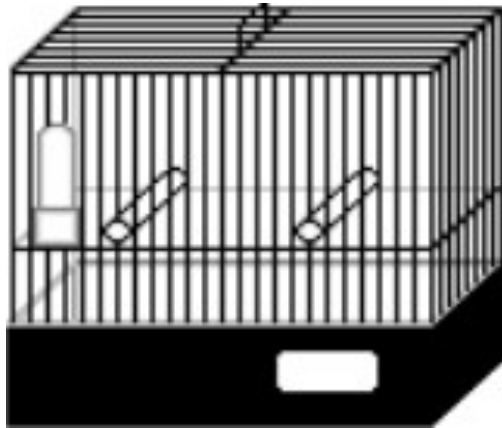

All colors are allowed.

Padovan

Standard

Points	Descriptions
Head, Crest, Neck and Collar 20	<p>Beak: adapted to the size of the bird. The crest is composed of soft feathers which fall on the beak and the eyes.</p> <p>The crest covers well the back of the head.</p> <p>Smooth and well released neck.</p> <p>Complete collar at the base. A minimal bare part on the back of the head is allowed.</p> <p>The non-crest bird should have a large and smooth head with well-defined eyebrows.</p>
Plumage 10	<p>Silky and abundant.</p> <p>Voluminous on the abdomen.</p>
Size 10	<p>18 – 19 cm / 7.08 – 7.48 inches with perfect proportions.</p>
Position 10	<p>Well erected.</p> <p>The head, body and tail form an angle of $\pm 65^\circ$ with the horizontal.</p>
Jabot 10	<p>Voluminous, rising with void below the jabot.</p> <p>Separation between jabot and abdomen with light frilling.</p>
Mantle 10	<p>Voluminous and symmetrically distributed to cover the entire back.</p>
Fins 10	<p>Voluminous, symmetrically implanted and raised to the mantle.</p>
Wings 5	<p>Regular and well adhered.</p>
Legs and Feet 5	<p>Well feathered thighs.</p> <p>Strong legs, feet and nails.</p> <p>Nails not corkscrewed.</p>
Tail 5	<p>Homogeneous, provided with rooster feathers on each side of the tail, long and broad.</p>
Condition 5	<p>Active, clean and in good health.</p> <p>All colors are allowed.</p>

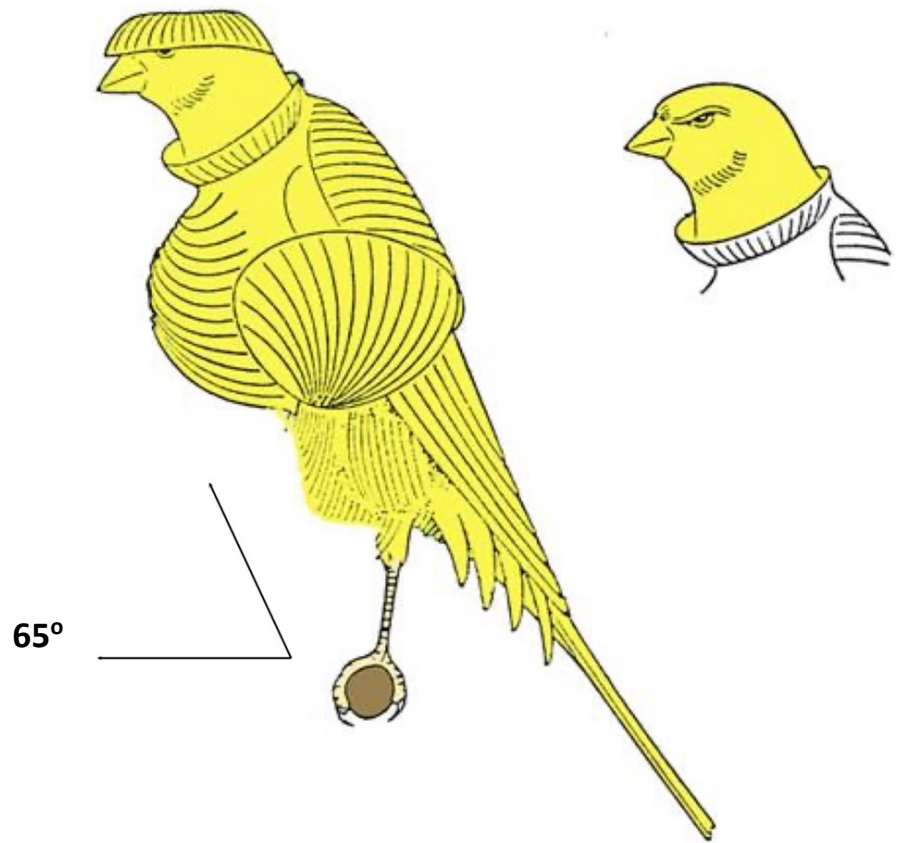

Technical drawing



Photograph



Judgement Sheet

	JUDGEMENT SHEET			
	Exhibitor			
	Breeder Number	Ring (s)	Country	
Padovan (Crest/Non Crest)				
Description:	Crest <input type="checkbox"/>	Non Crest <input type="checkbox"/>	E	Class
Cage N°				
Head, Crest, Neck and Collar	20			
Plumage	10			
Size	10			
Position	10			
Jabot	10			
Mantle	10			
Fins	10			
Wings	5			
Legs and Feet	5			
Tail	5			
Condition	5			
Total	100			
Observation :	Total			
	Harmony			
	Total for stamm			
Date :	Location :			
Judge :	Classification :			

Show cage :

Type C1 « Parisian Frill » with 2 round perches spaced 12 to 13 cm / 4.72 to 5.1 inches apart

Diameter 12 mm / 0.47 of an inch

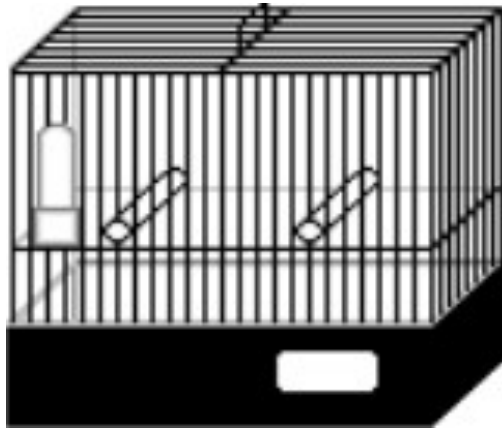

All colors are allowed.

Rogetto

Standard

Points	Descriptions
Size 20	Length 15 cm / 6 inches or less.
Head and Neck 20	Voluminous head with a full cap or full cap tendency. Abundant sideburns and with an obvious collar.
Mantle 10	Ample and symmetrical mantle. Voluminous in the shape of a rose. Double bouquet.
Fins 10	Thick and wide, well curved upwards, symmetrical.
Jabot 10	Full, symmetrical, starting from the abdomen to the chest without interruption.
Position 5	Erect. Head, trunk and tail in line.
Plumage 5	Silky.
Wings 5	Complete, well adhered to the body, not crossing each other.
Legs 5	In proportion with the bird. Nails twisted or tended to be twisted.
Tail 5	Short. Visible and symmetrical rooster feathers.
General Condition 5	Optimal health and with a perfectly clean plumage. A canary that is not in good health must be excluded from judging.

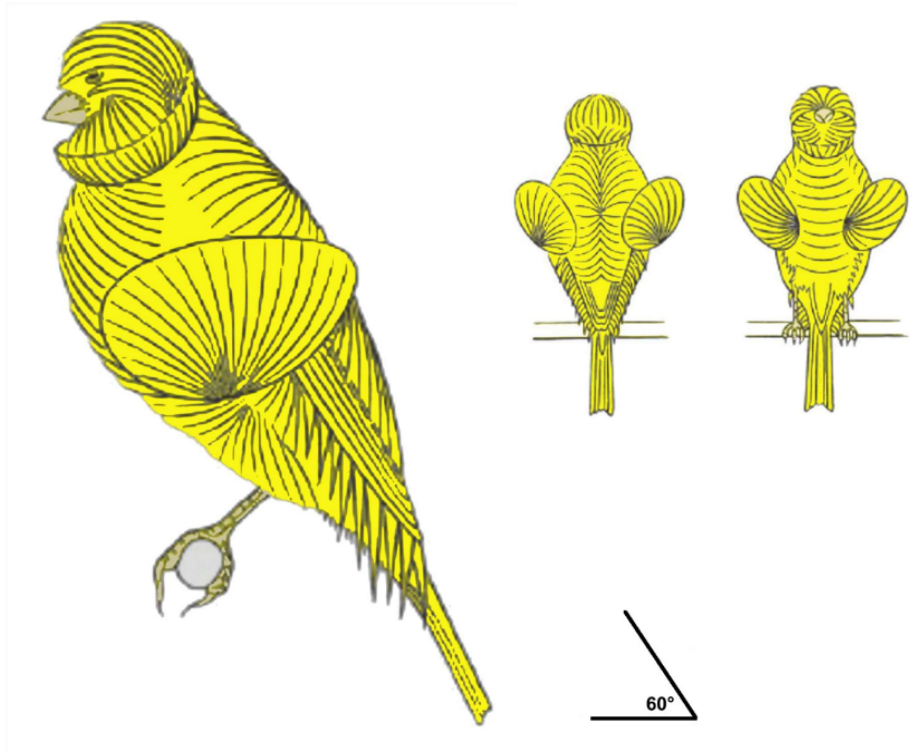

Technical drawing



Photograph



Judgement Sheet

 <p>C.O.M. CONFEDERATION ORNITHOLOGIQUE MONDIALE</p>	<h2 style="margin: 0;">JUDGEMENT SHEET</h2>			 <p>O.M.J. CONFEDERATION ORNITHOLOGIQUE MONDIALE</p>
	Exhibitor			
	Breeder Number	Ring (s)	Country	
Rogetto				
Description:			E	Class
Cage number				
Size maximum 15 cm / 6 inches	20			
Head and Neck	20			
Mantle	10			
Fins	10			
Jabot	10			
Position	5			
Plumage	5			
Wings	5			
Legs	5			
Tail	5			
General condition	5			
Total	100			
Observation :		Total		
		Harmony		
		Total for stamm		
Date :		Location :		
Judge :		Classification :		



Show cage :

Type C1 « Parisian Frill » with 2 round perches spaced 12 to 13 cm / 4.72 to 5.1 inches apart

Diameter 12 mm / 0.47 of an inch

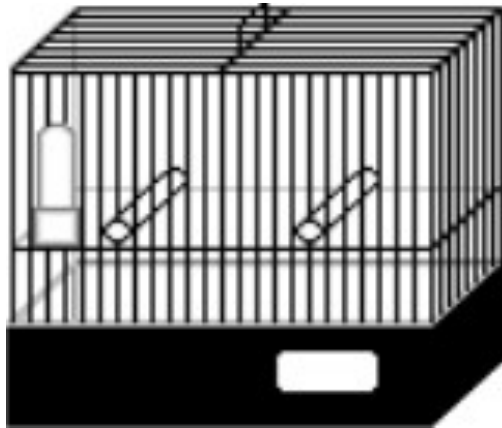

All colors are allowed.

